

## TEGNINGSLISTE

**OPPDRAKSGIVER:**  
**HALDEN KOMMUNE**

**OPPDRAGSTITTEL:**  
**VVA og fjernvarme, Tyska-Hollenderen**

Revidert: 03.05.2018

Nr.	Tittel	Dato	Revidert / dato			
			A	B	C	D
H01	Oversiktstegning	03.05.2018				
H02	Plan og lengdeprofil nedre del, pel 0-350	03.05.2018				
H03	Plan og lengdeprofil nedre del, pel 350-655	03.05.2018				
H04	Kumskisser og grøftesnitt nedre del	03.05.2018				
H05	Normalprofil og veioppbygging	20.03.2018				
H06	Plan og lengdeprofil jernbanekryssing	03.05.2018				
H07	Plan og lengdeprofil Refneveien	03.05.2018				
H08	Kumskisser øvre del	03.05.2018				
H09	Lengdeprofil vei, pel 0-665	19.12.2017				
U01	Tverrprofil, pel 0 - 80	19.12.2017				
U02	Tverrprofil, pel 090 - 170	19.12.2017				
U03	Tverrprofil, pel 180 - 260	19.12.2017				
U04	Tverrprofil, pel 270 - 350	19.12.2017				
U05	Tverrprofil, pel 360 - 440	19.12.2017				
U06	Tverrprofil, pel 450 - 530	19.12.2017				
U07	Tverrprofil, pel 540 - 620	19.12.2017				
U08	Tverrprofil, pel 630 - 650	19.12.2017				

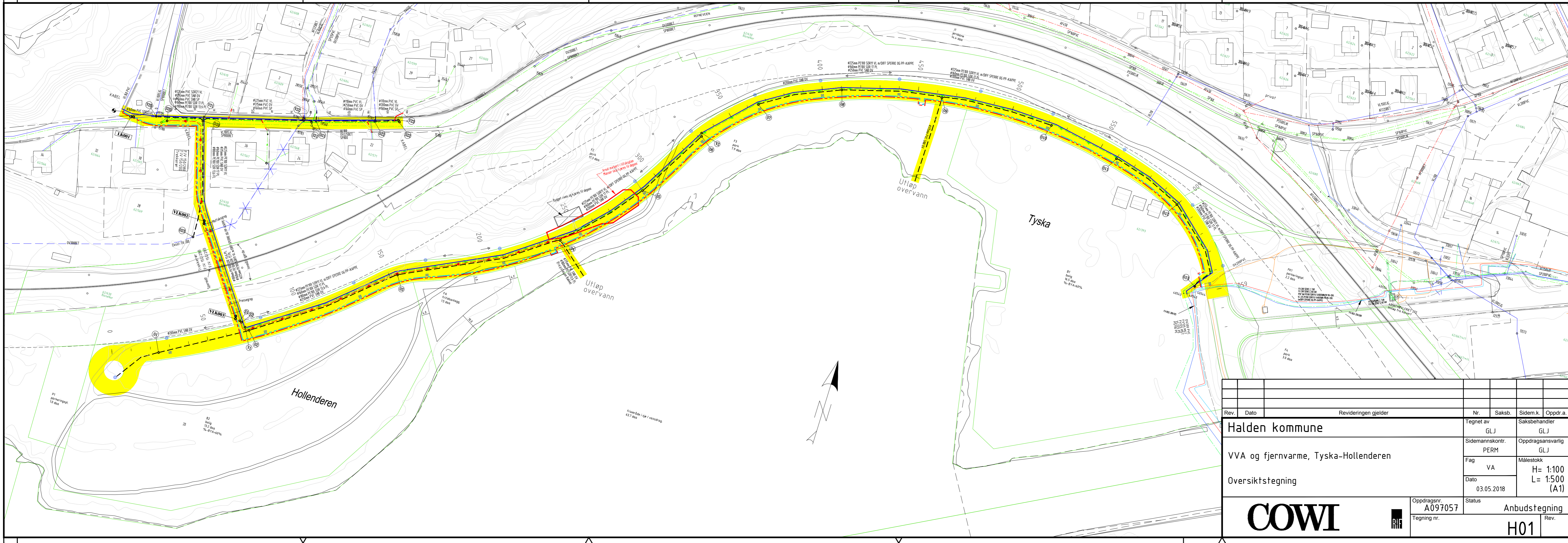

Rev.	Dato	Revideringen gjelder	Nr.	Saksb.	Sidem.k.	Oppdr.a.
		Halden kommune		Tegnet av GLJ		Saksbehandler GLJ
		VVA og fjernvarme, Tyska-Hollenderen		Sidemannsktr. PERM		Oppdragsansvarlig GLJ
		Oversiktstegning		Fag VA		Målestokk H= 1:100 L= 1:500 (A1)
				Dato 03.05.2018		
		Oppdragsnr. A097057	Status		Anbudstegning	
		Tegning nr.	Rev.		H01	











**Deleliste kum S1**  
 1 Stk. Ø150mm Balo sluseventil med strekkfast tilkobling til Ø180mm PE  
 1 Stk. spindelforlenger avsluttes i en 650mm kumring

**Deleliste kum S2**  
 1 Stk. Ø150mm Balo sluseventil med strekkfast tilkobling til Ø160mm PE  
 1 Stk. spindelforlenger avsluttes i en 650mm kumring

**Deleliste kum V1**  
 1 Stk. Ø200mm Ventil-T m/brannavstikk og serviceuttak  
 2 Stk. Ø200/225mm Løstflenser og krage for PE-rør  
 1 Stk. Ø100mm mellomring med kuleventil  
 1 Stk. Ø40mm lufteklokke  
 1 Stk. Ø100mm Brannventil med brannventilbeskyttelse  
 Ajustar stige eller tilsvarende

**Deleliste kum V2**  
 1 Stk. Ø200mm Ventil-T m/brannavstikk og serviceuttak  
 2 Stk. Ø200/225mm Løstflenser og krage for PE-rør  
 1 Stk. Ø100mm mellomring med kuleventil  
 1 Stk. Ø40mm lufteklokke  
 1 Stk. Ø100mm Brannventil med brannventilbeskyttelse  
 Ajustar stige eller tilsvarende

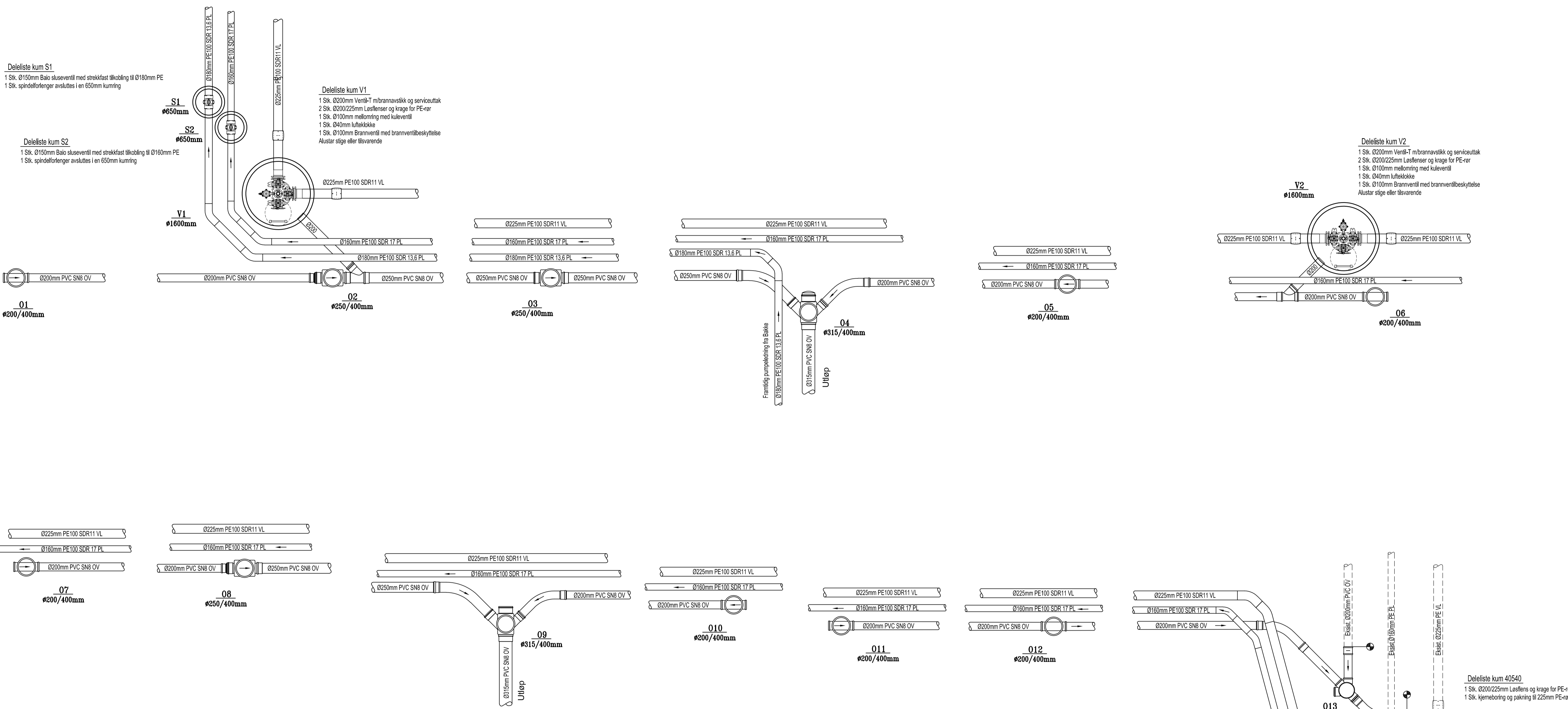

**GRØFTESNITT**  
 Pel 70-240 (Kum O2-O4)

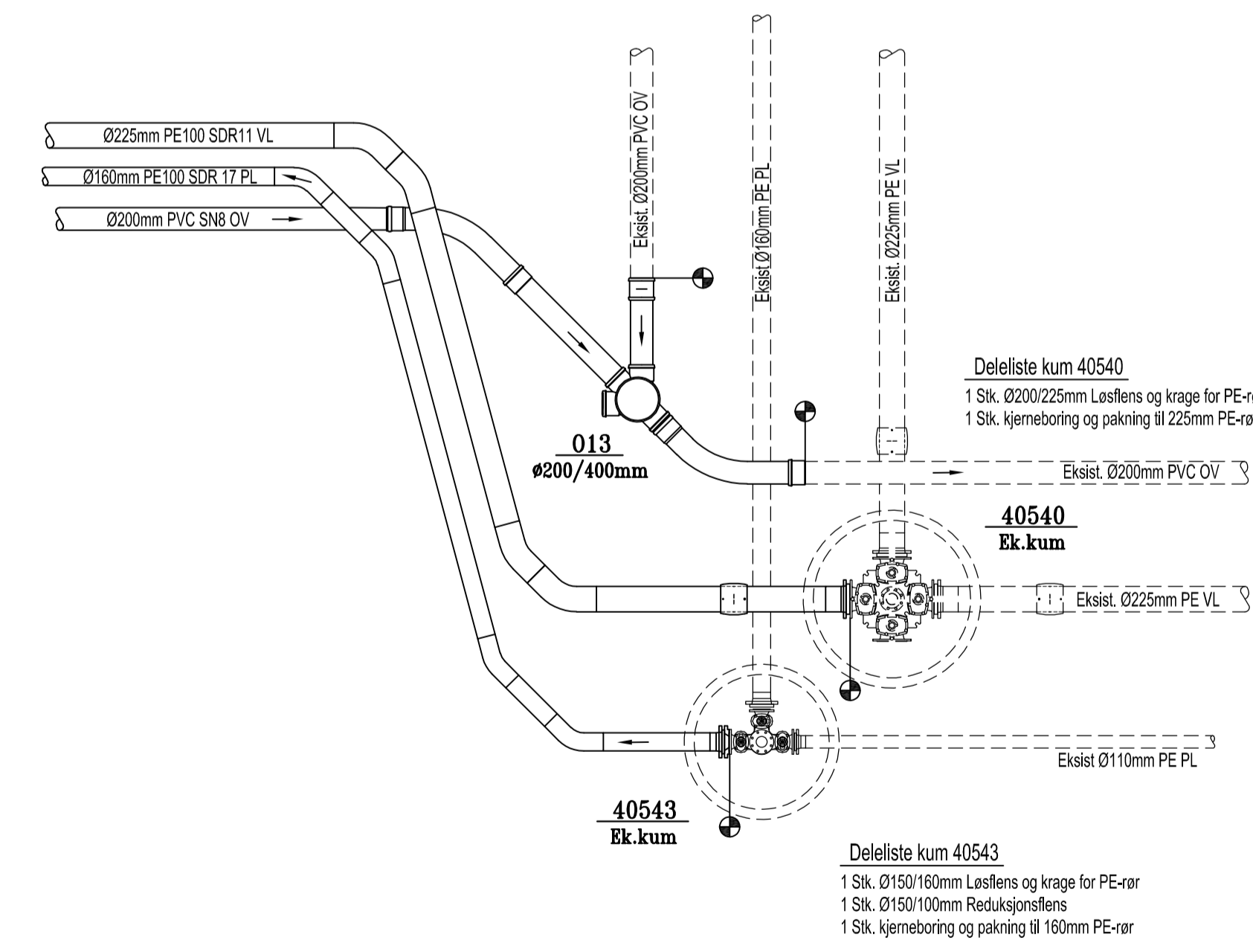
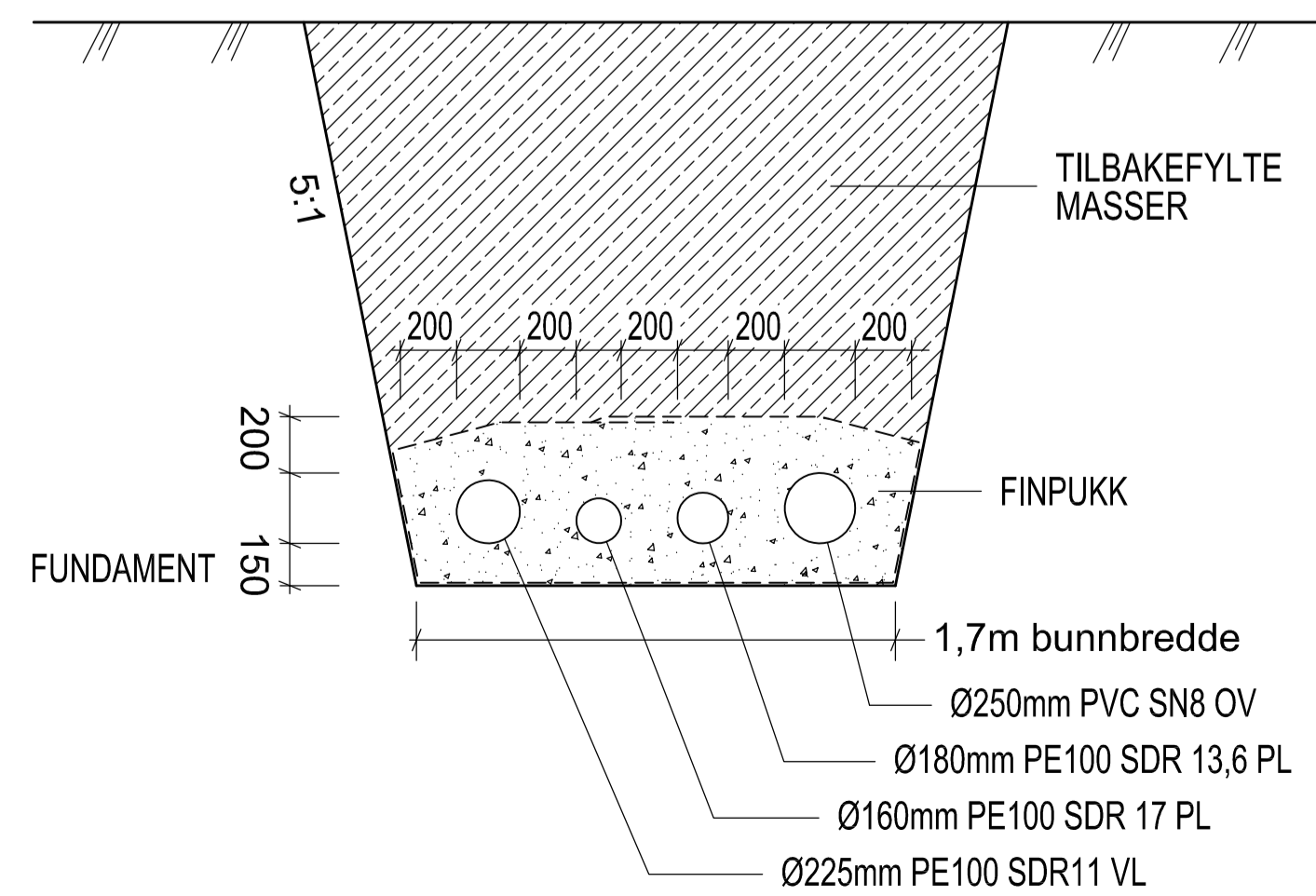

**Deleliste kum 40540**  
 1 Stk. Ø200/225mm Løstflens og krage for PE-rør  
 1 Stk. kjemeboring og pakning til 225mm PE-rør

**Deleliste kum 40543**  
 1 Stk. Ø150/160mm Løstflens og krage for PE-rør  
 1 Stk. Ø150/100mm Reduksjonsflens  
 1 Stk. kjemeboring og pakning til 160mm PE-rør

Rev.	Dato	Revisjonen gjelder	Nr.	Saksb.	Sidem.k.	Oppdr.a.
Halden kommune			Tegnet av	GLJ	Saksbehandler	GLJ
VVA og fjernvarme, Tyska-Hollenderen			Sidemannskont.	PERM	Oppdragsansvarlig	GLJ
Kumskisser og grøftesnitt nedre del			Fag	VA	Målestokk	A1 1:50
			Dato	03.05.2018		
			Oppdragsnr.	A097057	Anbudstegning	
			Tegning nr.		Rev.	
			<b>H04</b>			

Format: A3 Filnavn: 0:\A095000\A097057\3 Prosjektdokumenter\3.7 Tegninger\Tegning\H05 Normalprofil.dwg Xref:

## Normalprofil hovedvei M 1:50

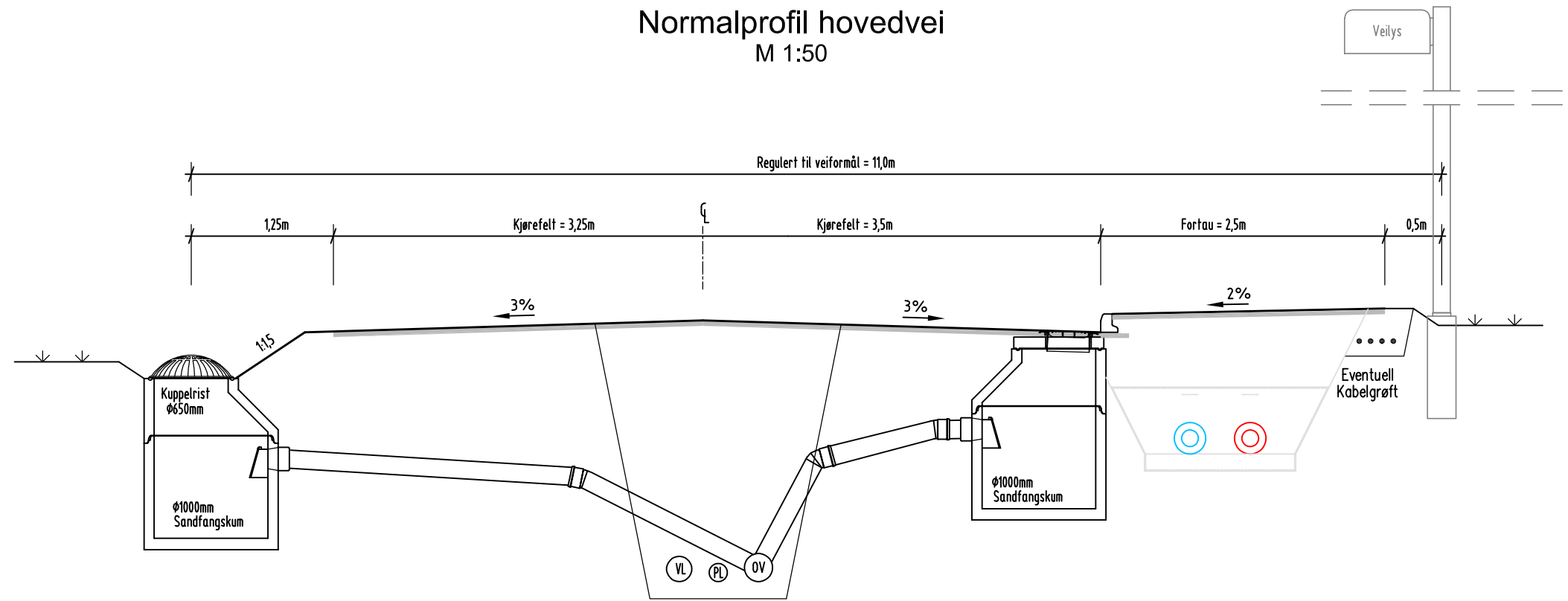

## Veioppbygging M 1:10

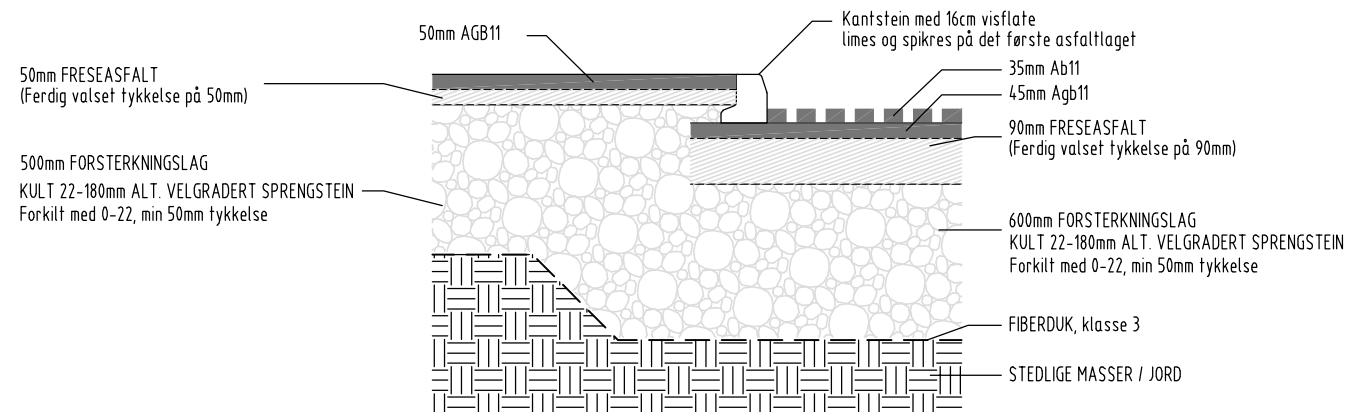

Rev.	Dato	Revideringen gjelder	Nr.	Saksb.	Sidem.k.	Oppdr.a.
HALDEN KOMMUNE			Tegnet av GLJ	Saksbehandler GLJ		
VVA og fjernvarme, Tyska - Hollenderen			Sidemannskontr. ADBR	Oppdragsansvarlig GLJ		
NORMALPROFIL OG VEIOPPBYGGING				Målestokk 1:10 1:50		
			Dato 20.03.2018			
COWI			Oppdragsnr. A097057	Status Anbudstegning		
RTG			Tegning nr. H05	Rev.		

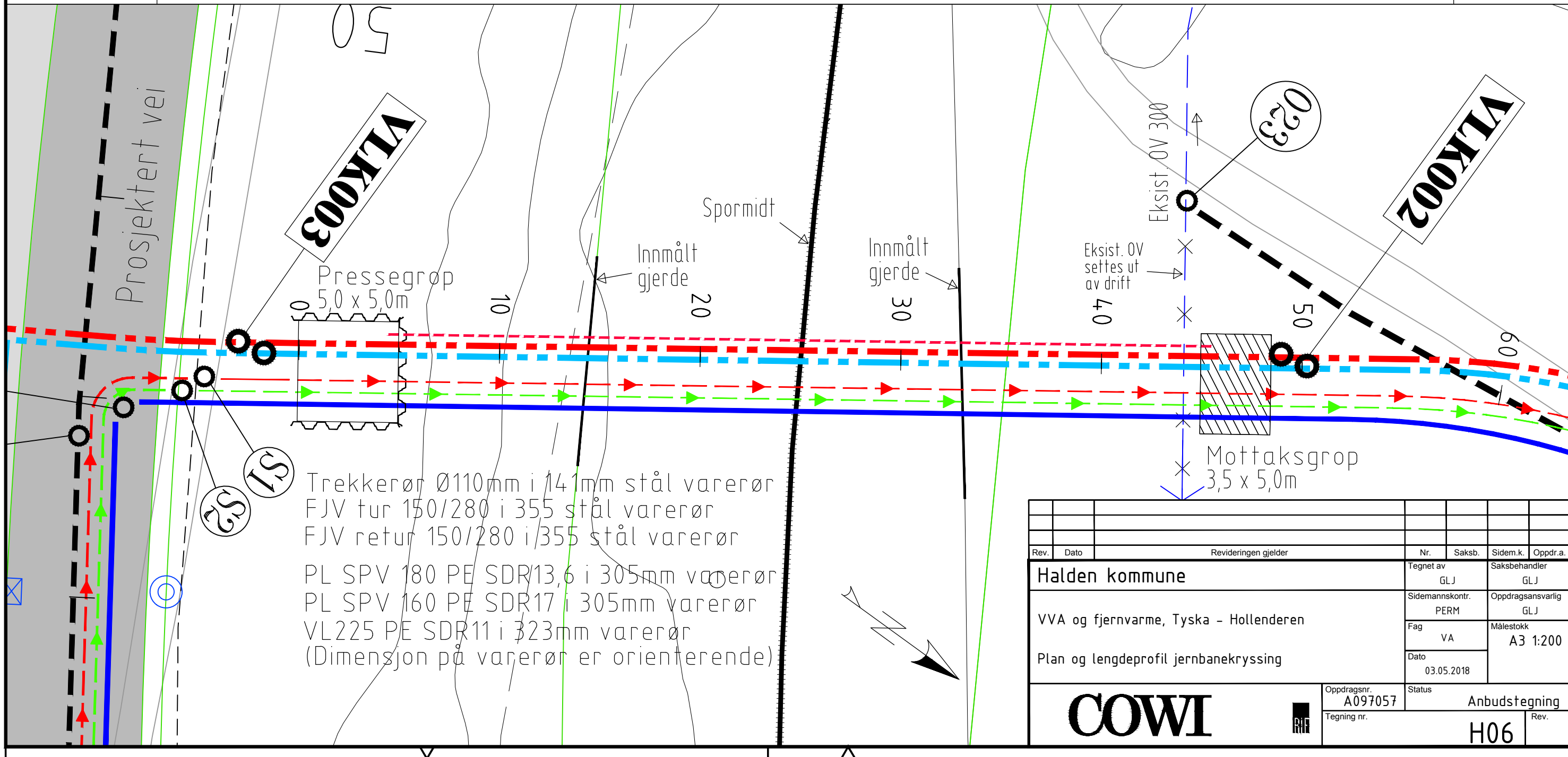
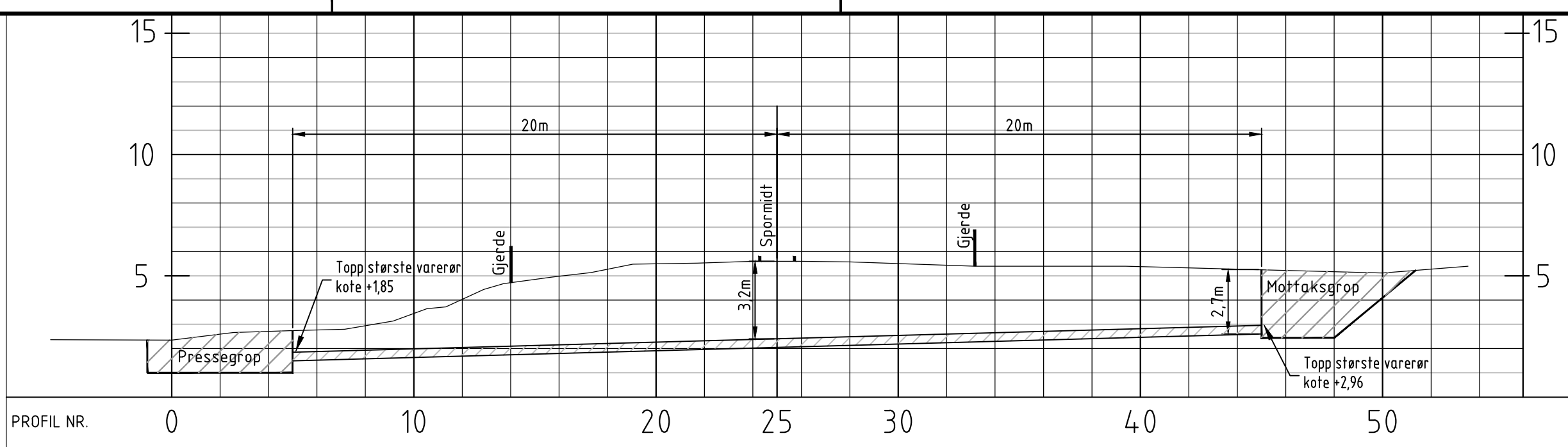

Trekkerør Ø110mm i 141mm stål varerør  
 FJV tur 150/280 i 355 stål varerør  
 FJV retur 150/280 i 355 stål varerør  
 PL SPV 180 PE SDR13,6 i 305mm varerør  
 PL SPV 160 PE SDR17 i 305mm varerør  
 VL225 PE SDR11 i 323mm varerør  
 (Dimensjon på varerør er orienterende)

Rev.	Dato	Revideringen gjelder	Nr.	Saksb.	Sidem.k.	Oppdr.a.
Halden kommune			Tegnet av	Saksbehandler		
VVA og fjernvarme, Tyska - Hollenderen			GLJ	GLJ		
Plan og lengdeprofil jernbanekryssing			Sidemannsktr.	Oppdragsansvarlig		
			PERM	GLJ		
			Fag	Målestokk		
			VA	A3 1:200		
			Dato			
			03.05.2018			
Oppdragsnr.			Status			
A097057			Anbudstegning			
Tegning nr.			Rev.			
H06						

**COWI**









**Deleliste kum V20**

- 1 Stk. Ø150mm Ventil-kryss m/brannavstikk og serviceuttak
- 1 Stk. Ø200/225mm EKS-Flensmuffe for PVC
- 1 Stk. Ø150/160mm EKS-Flensmuffe for PVC
- 1 Stk. Ø100/110mm EKS-Flensmuffe for PVC
- 1 Stk. Ø100/100mm Tylon Flensmuffe for STJ
- 1 Stk. Ø200/150mm Reduksjonsflens
- 2 Stk. Ø150/100mm Reduksjonsflenser
- 1 Stk. Ø100mm Flensbeleg 90 gr.
- 1 Stk. Ø100mm Mellomring med kuleventil
- 1 Stk. Ø40mm Lufteklokke
- 1 Stk. Ø100mm Brannventil med brannventilbeskyttelse
- Alustar stige eller tilsvarende

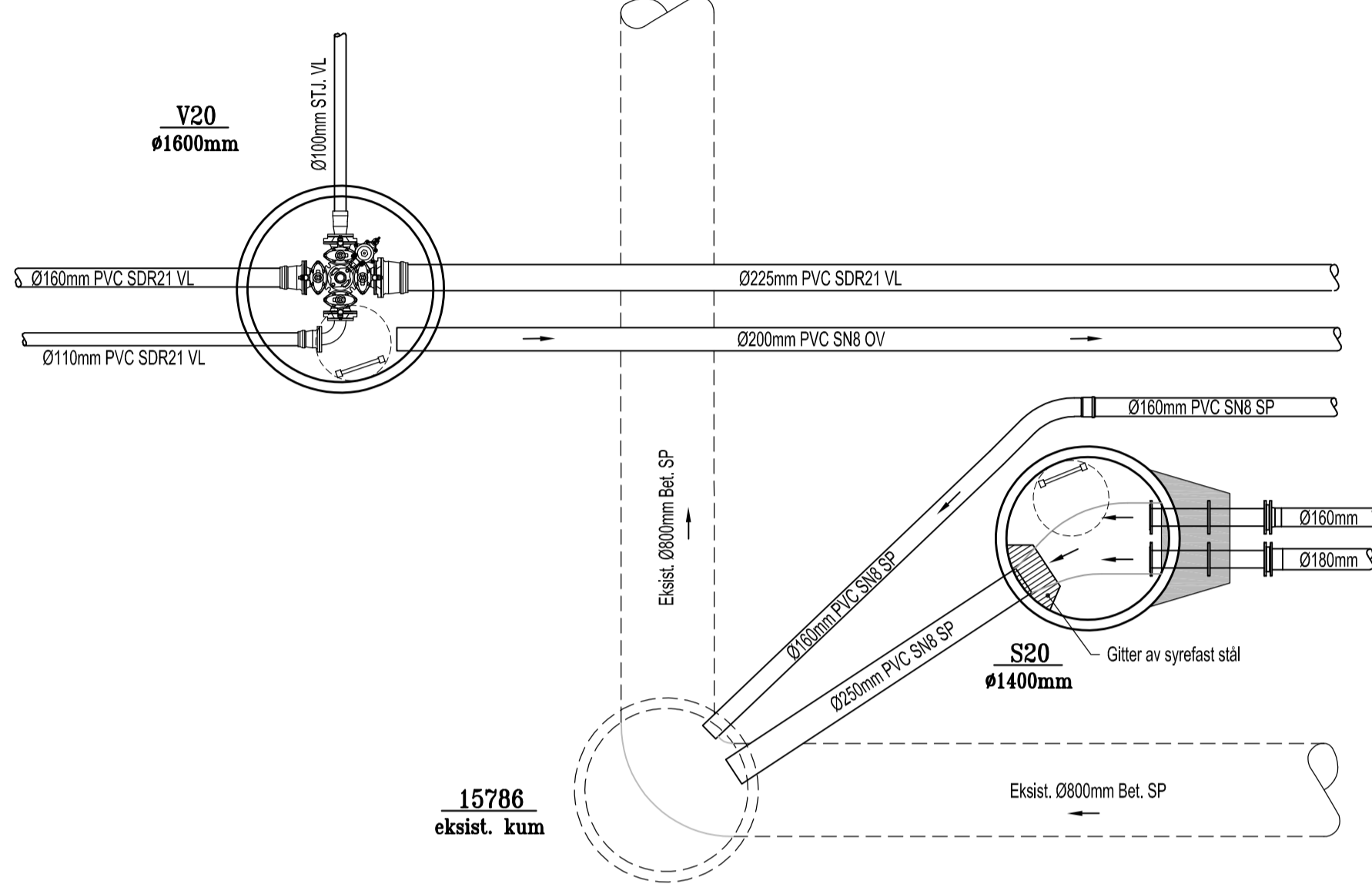

**Deleliste kum V21**

- 1 Stk. Ø200mm Ventil-kryss m/brannavstikk og serviceuttak
- 2 Stk. Ø200/225mm EKS-Flensmuffe for PVC
- 1 Stk. Ø200/225mm Lestflens og krage for PE-rør
- 1 Stk. Ø100/110mm EKS-Flensmuffe for PVC
- 1 Stk. Ø100mm Brannventil med brannventilbeskyttelse
- Alustar stige eller tilsvarende

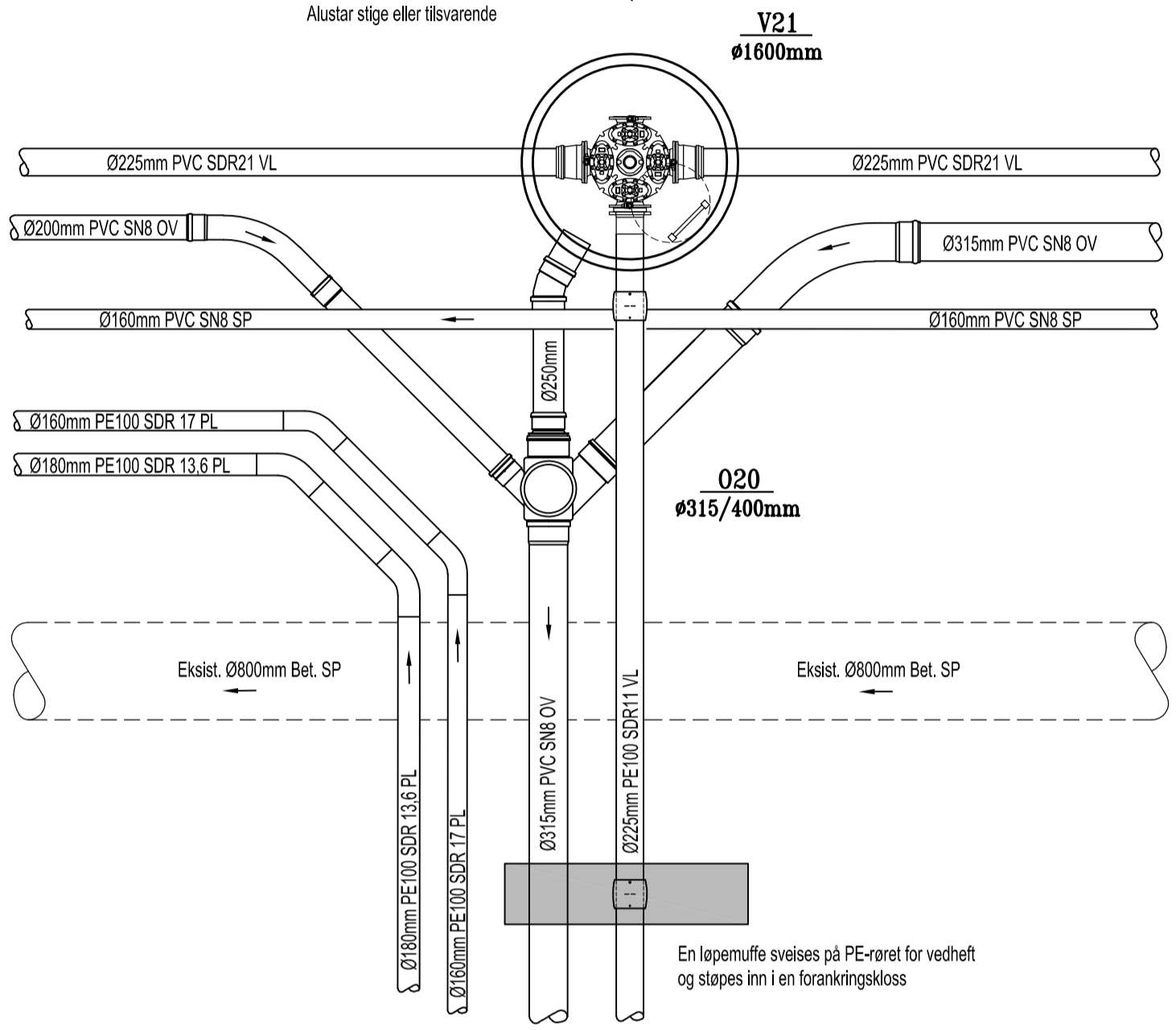

**Deleliste kum V22**

- 1 Stk. Ø150mm Ventil-kryss m/brannavstikk og serviceuttak
- 1 Stk. Ø200/225mm EKS-Flensmuffe for PVC
- 1 Stk. Ø100/110mm EKS-Flensmuffe for PVC
- 1 Stk. Ø150/150mm Tylon Flensmuffe for STJ
- 1 Stk. Ø200/150mm Reduksjonsflens
- 1 Stk. Ø150/100mm Reduksjonsflenser
- 1 Stk. Ø100mm Brannventil med brannventilbeskyttelse
- Alustar stige eller tilsvarende

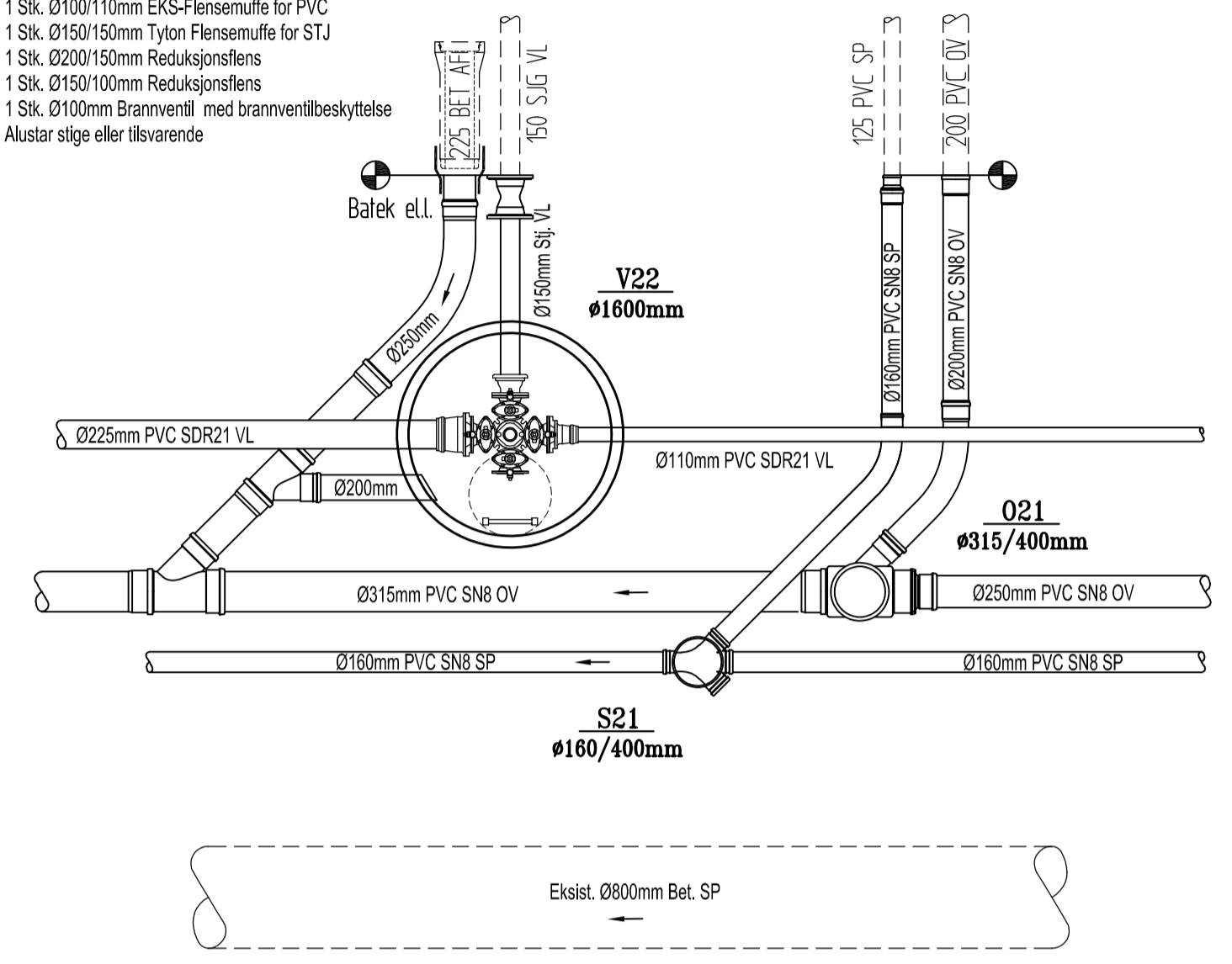

**Snitt S20**  
Ø1400mm

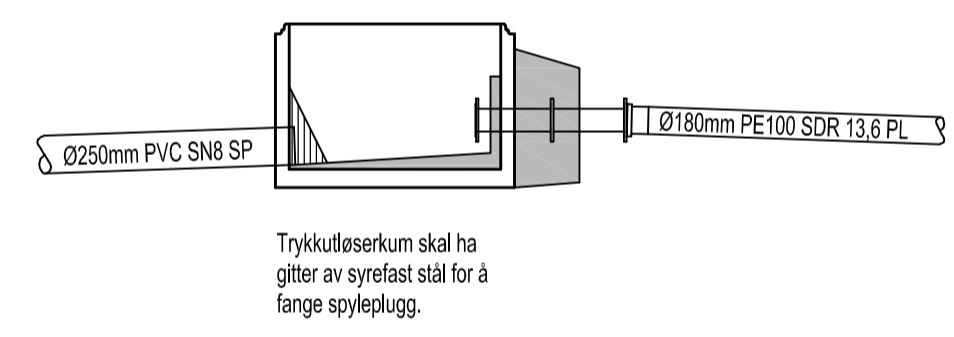

**Deleliste kum V23**

- 1 Stk. Ø100/100mm Flense T-rør
- 1 Stk. Ø100mm Sluseventil
- 1 Stk. Ø100/110mm EKS-Flensmuffe for PVC
- 1 Stk. Ø100mm Mellomring med kuleventil
- 1 Stk. Ø40mm Lufteklokke
- 1 Stk. Ø100mm Brannventil med brannventilbeskyttelse
- Alustar stige eller tilsvarende

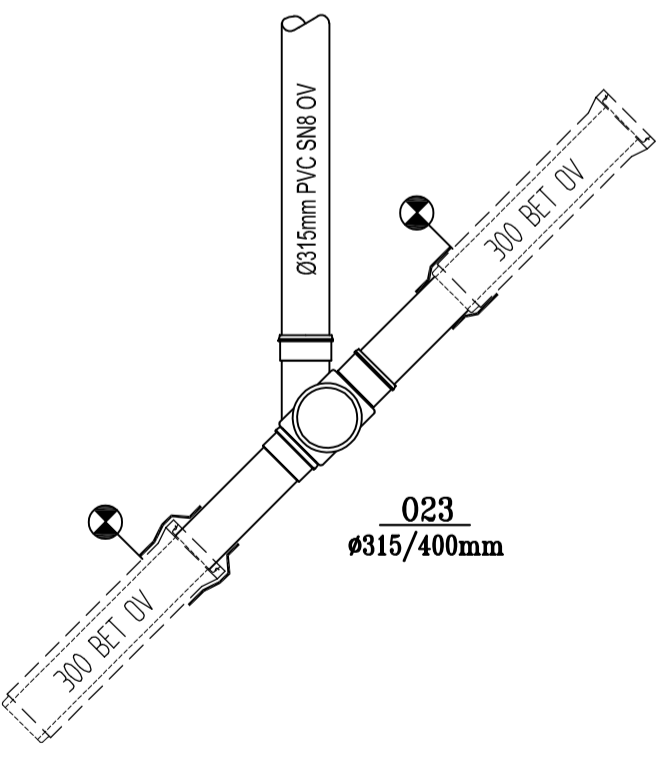
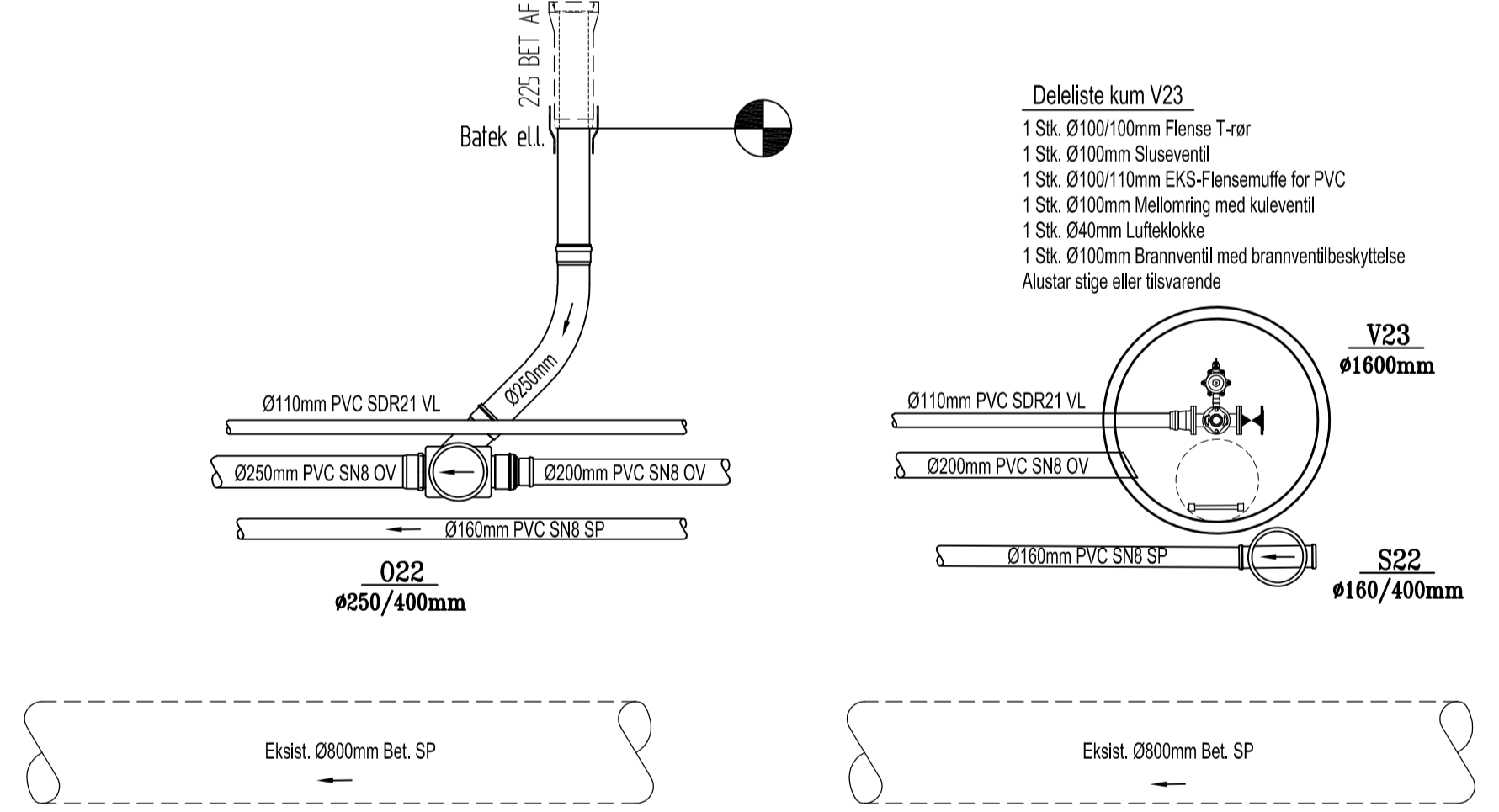

Format: A1 E:\navn: D:\0355000\A097057\3 Prosjekt\dokumenter\3.1.1\teminer\Tegning\104\_00\_108\_kumskisser.dwg Xref:

Rev.	Dato	Revideringen gjelder	Nr.	Saksb.	Sidem.k.	Oppdr.a.
Halden kommune			Tegnet av	GLJ	Saksbehandler	GLJ
VVA og fjernvarme, Tyska-Hollenderen			Sidemannskont.	PERM	Oppdragsansvarlig	GLJ
Kumskisser øvre del			Fag	VA	Målestokk	A1 1:50
			Dato	03.05.2018		
			Oppdragsnr.	A097057	Status	Anbudstegning
			Tegning nr.		Rev.	H08

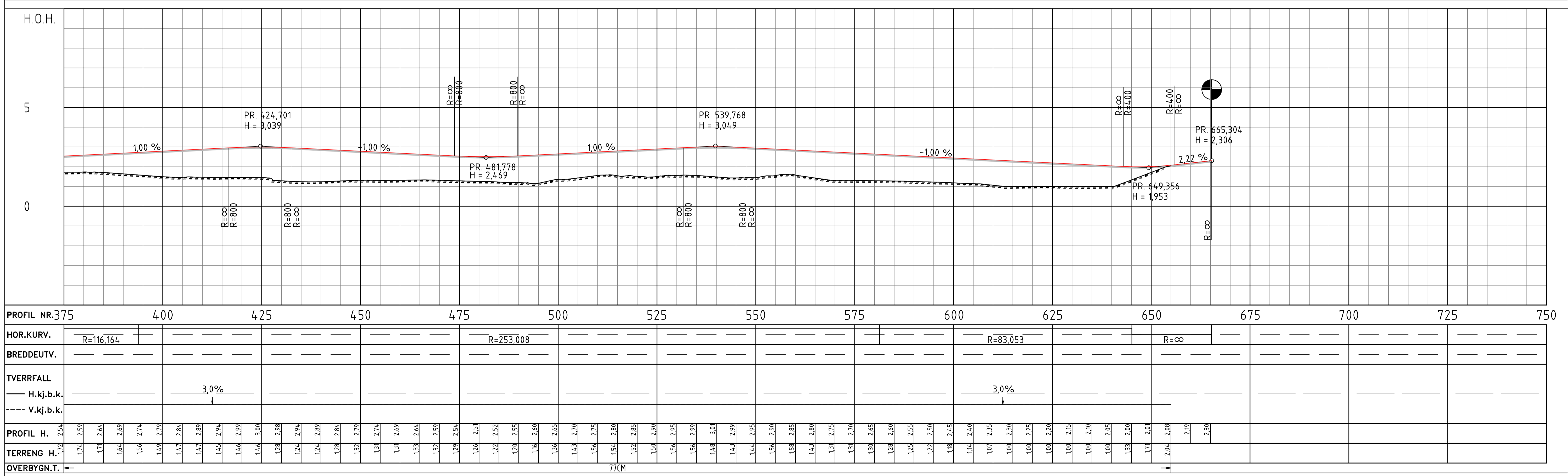
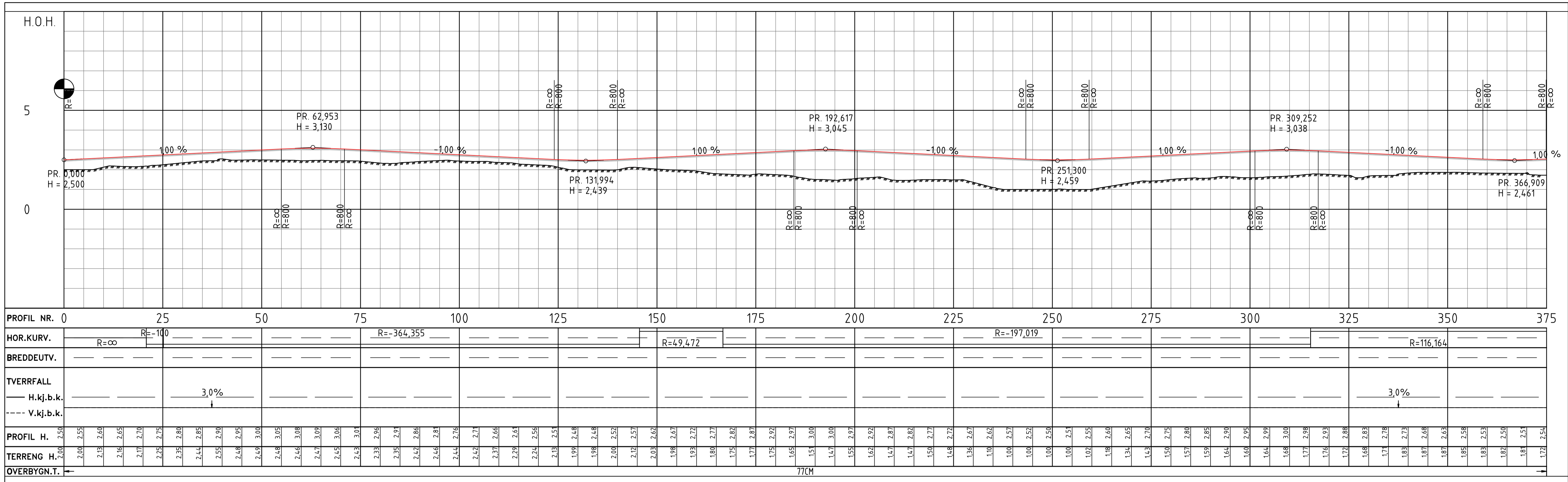

Rev.	Dato	Revideringen gjelder	Nr.	Saksb.	Sidem.k.	Oppdr.a.
Halden kommune			Tegnet av ADBR Saksbehandler			
VVA og fjernvarme, Tyska - Hollenderen			Sidemannskont. OLER Oppdragsansvarlig GLJ			
Lengdeprofil vei, pel 0-665			Fag VEG Målestokk A1: 1:500 A3: 1:1000			
			Dato 19.12.2017			
Oppdragsnr. A097057			Status Anbudstegning			
Tegning nr.			Rev.			
COWI			H09			



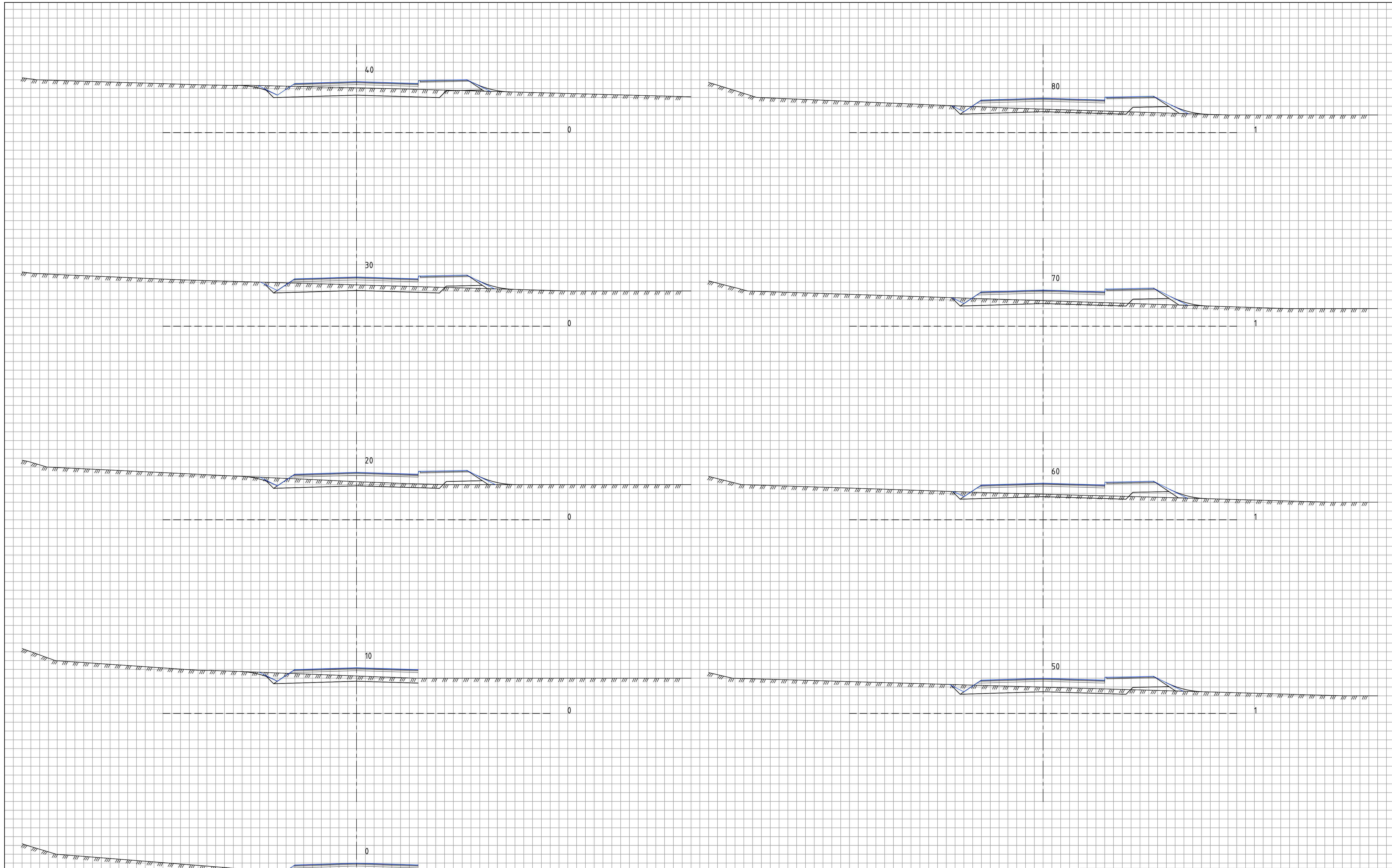

Rev.	Dato	Revideringen gjelder	Nr.	Saksb.	Sidem.k.	Oppdr.a.
Halden kommune			Tegnet av	Saksbehandler		
VA Tyska Hollenderen			ADBR	ADBR		
Tverrprofiler 0 - 80			Sidemannskont.	Oppdragsansvarlig		
			OLER	GLJ		
			Fag	Målestokk		
			VEG	A1: 1:100		
			Dato	A3: 1:200		
			19.12.2017			
			Oppdragsnr.	Status		
			A097057	Konkurransgrunnlag		
			Tegning nr.	Rev.		
				U001		

**COWI**



U001

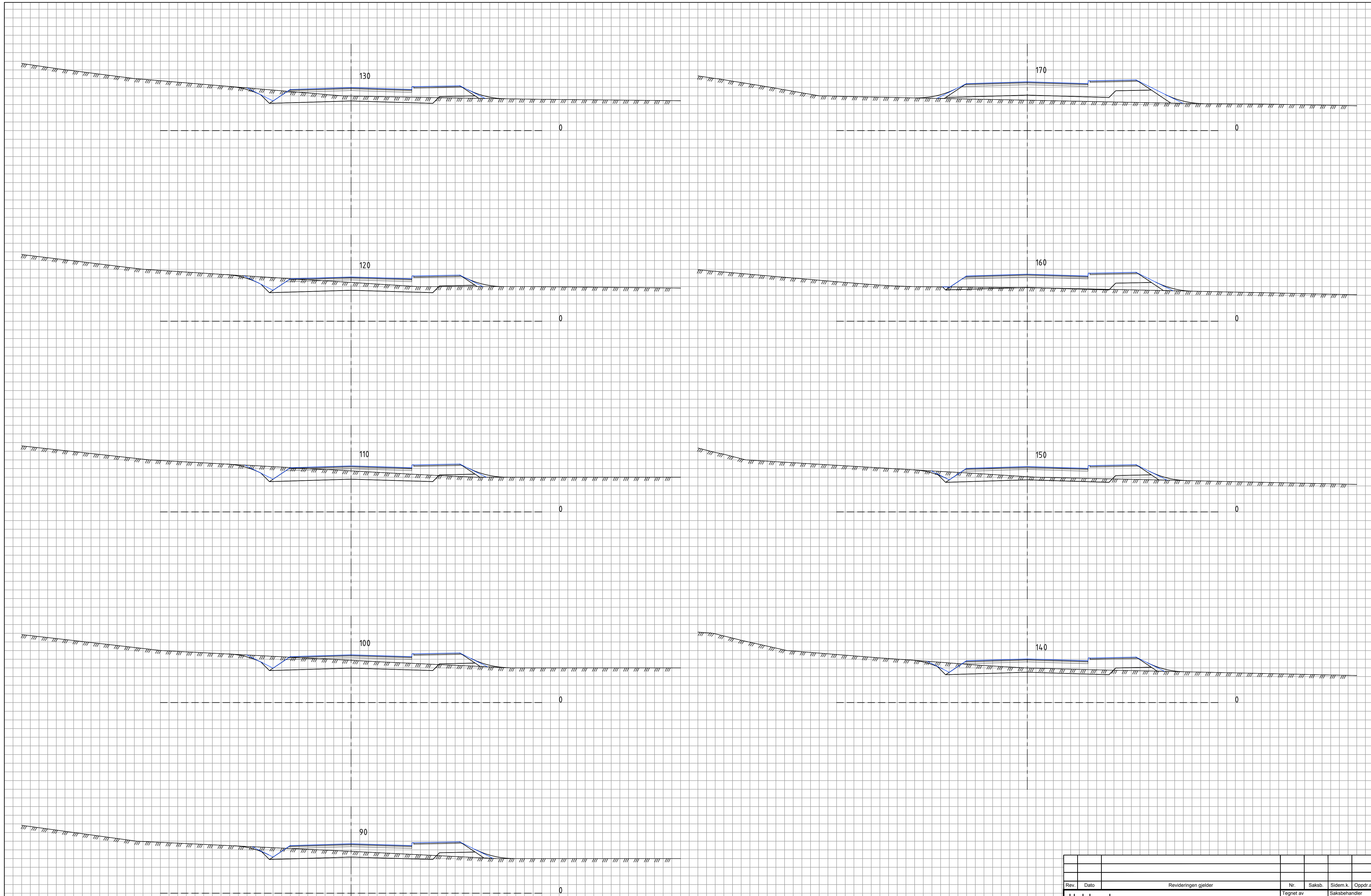

Rev.	Dato	Revideringen gjelder	Nr.	Saksb.	Sidem.k.	Oppdr.a.
Halden kommune			Tegnet av ADBR		Saksbehandler	
VA Tyska Hollenderen			Sidemannskont. OLER		Oppdragsansvarlig GLJ	
Tverrprofiler 90 - 170			Fag VEG		Målestokk A1: 1:100 A3: 1:200	
			Dato 19.12.2017			
COWI			Oppdragsnr. A097057		Status Konkurransgrunnlag	
			Tegning nr.		Rev. U002	



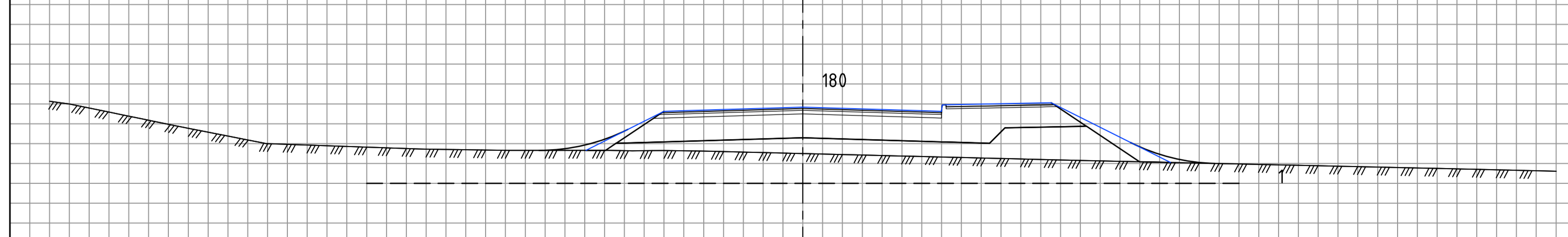
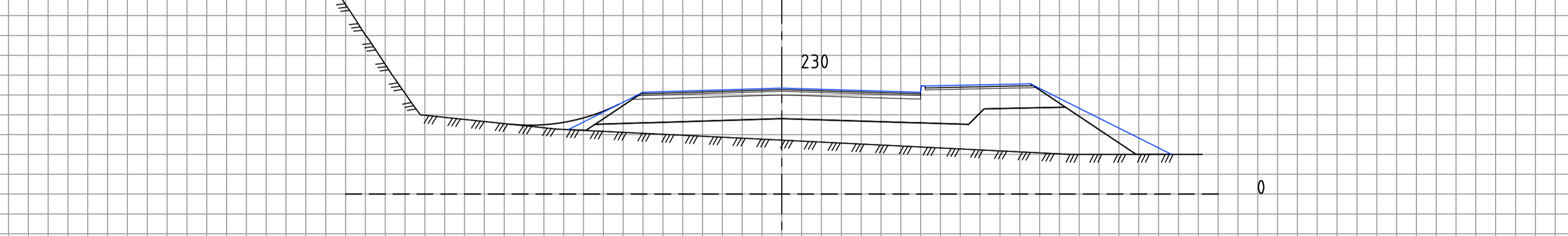
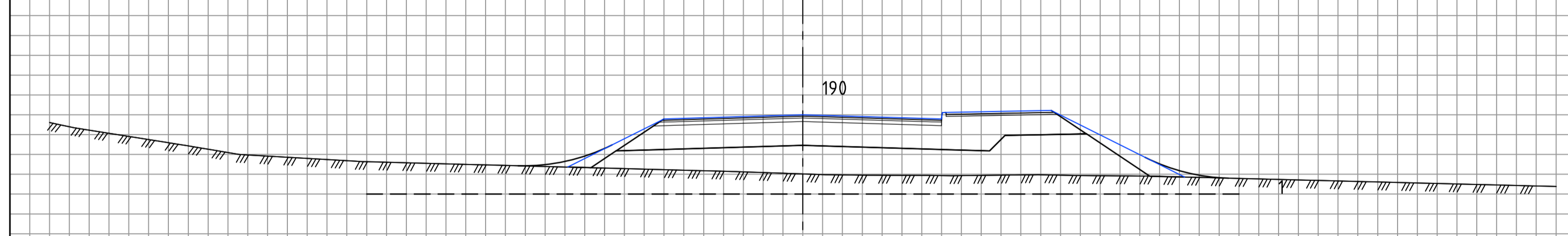
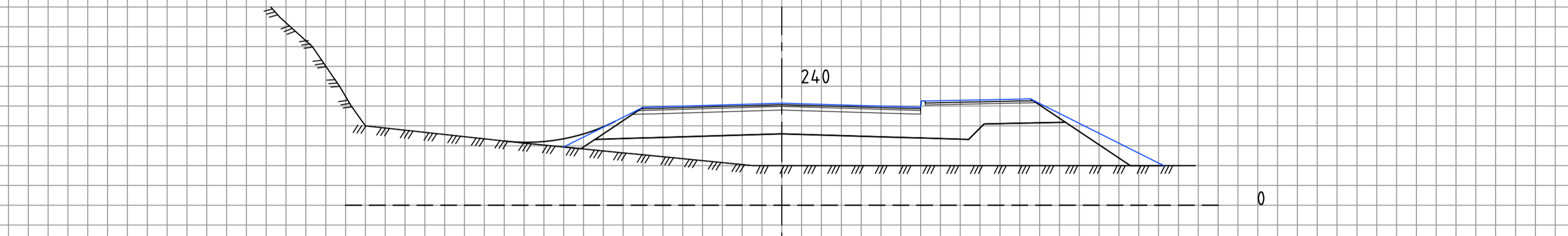
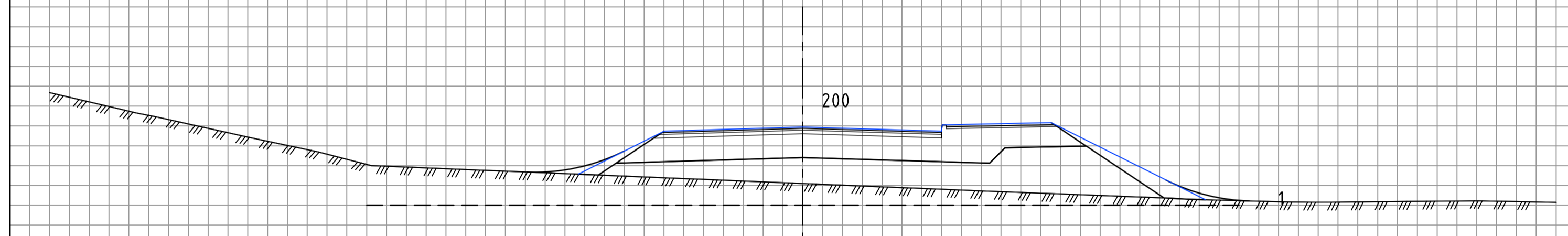
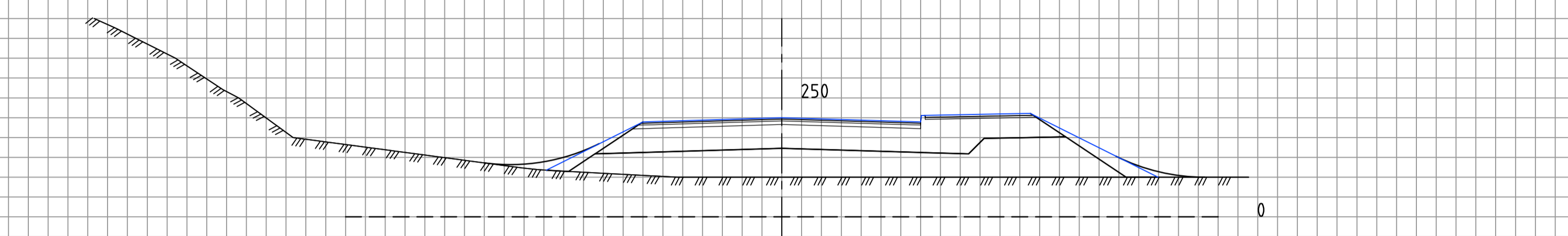
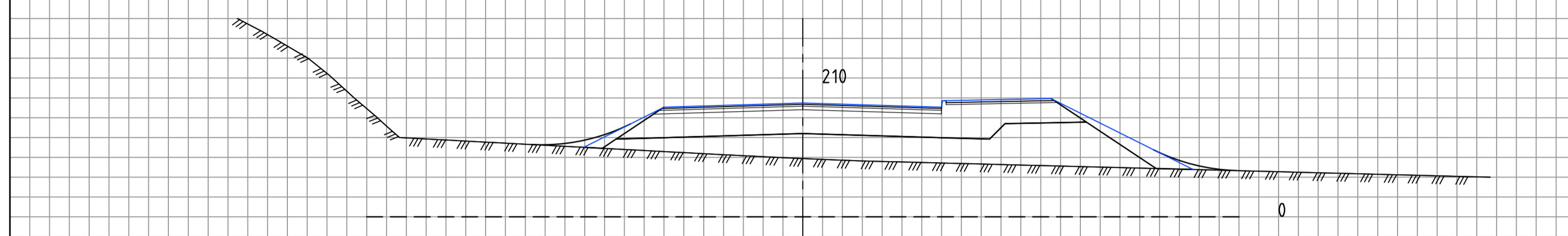
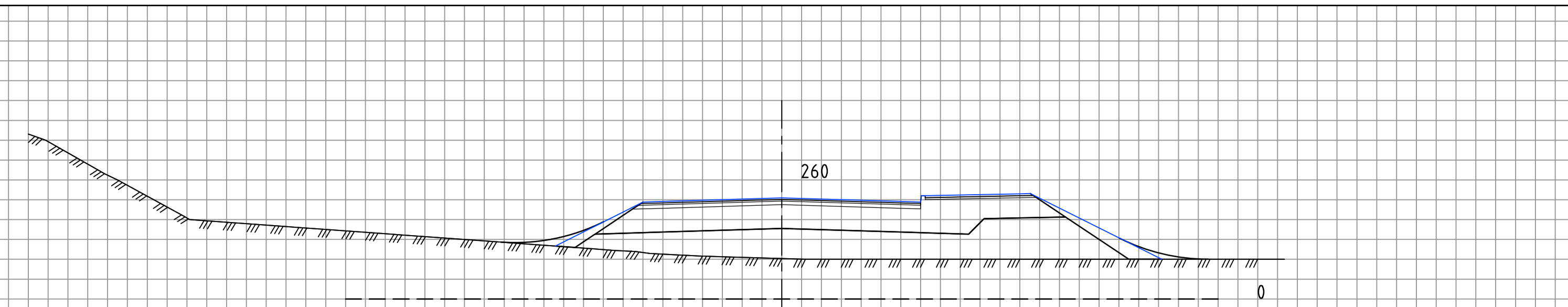
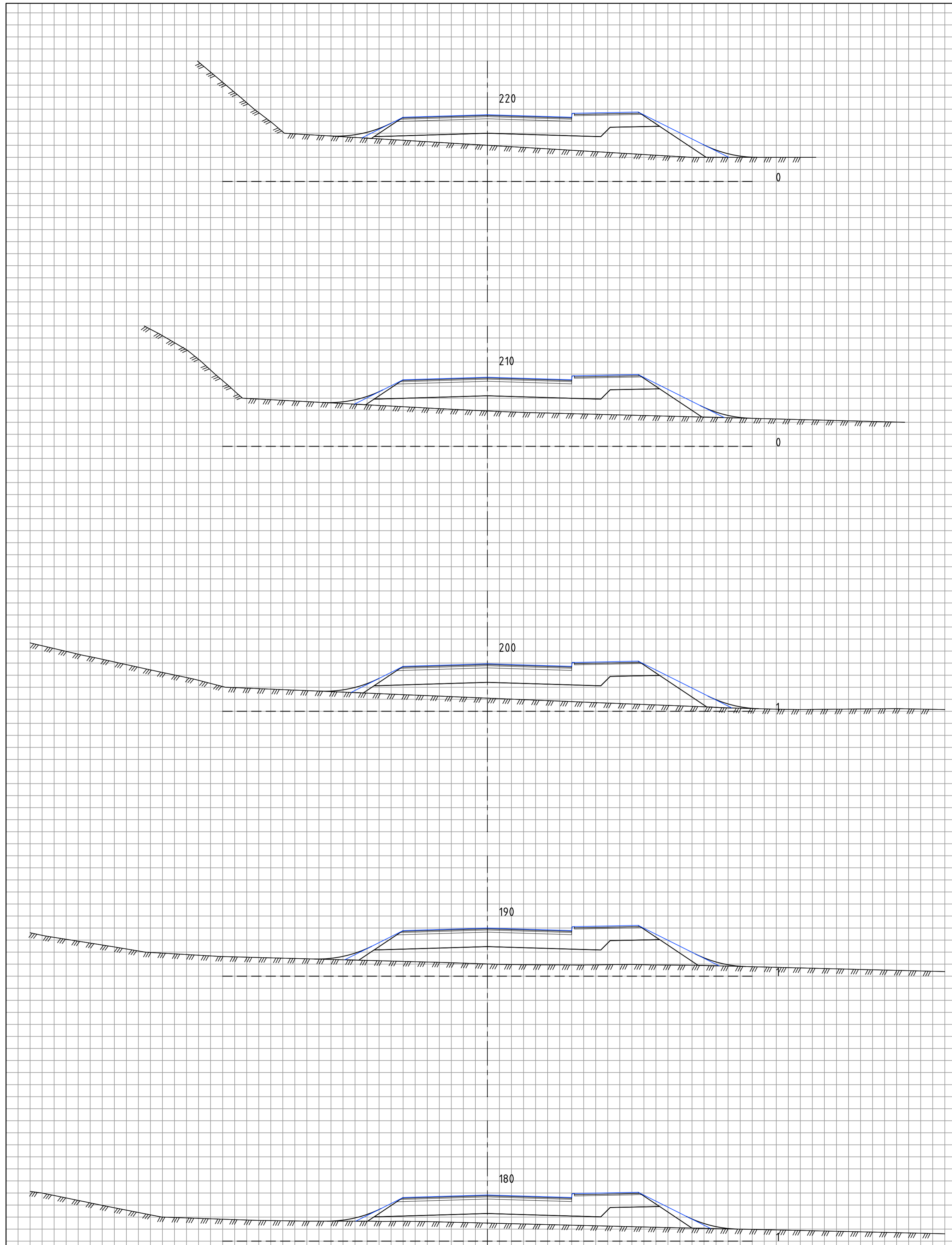

Rev.	Dato	Revideringen gjelder	Nr.	Saksb.	Sidem.k.	Oppdr.a.
Halden kommune			Tegnet av	Saksbehandler		
VA Tyska Hollenderen			ADBR	GLJ		
Tverrprofiler 180 - 260			Sidemannskont.	Oppdragsansvarlig		
			OLER	GLJ		
			Fag	Målestokk		
			VEG	A1: 1:100		
			Dato	A3: 1:200		
			19.12.2017			
COWI			Oppdragsnr.	Status		
RIF			A097057	Konkurransgrunnlag		
			Tegning nr.	Rev.		
				U003		

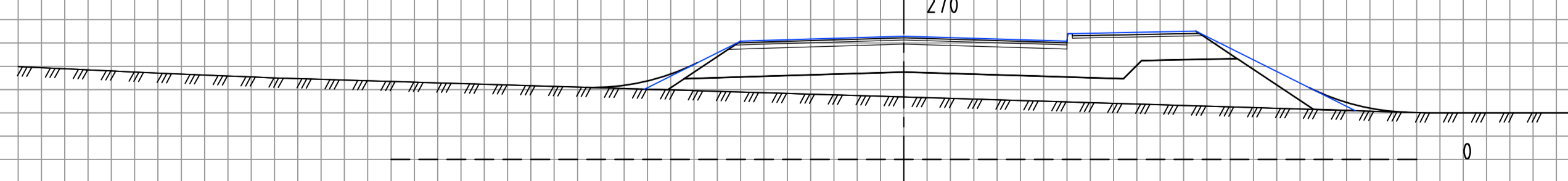
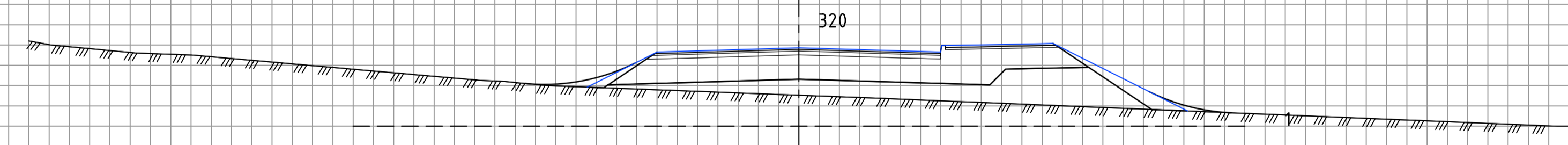
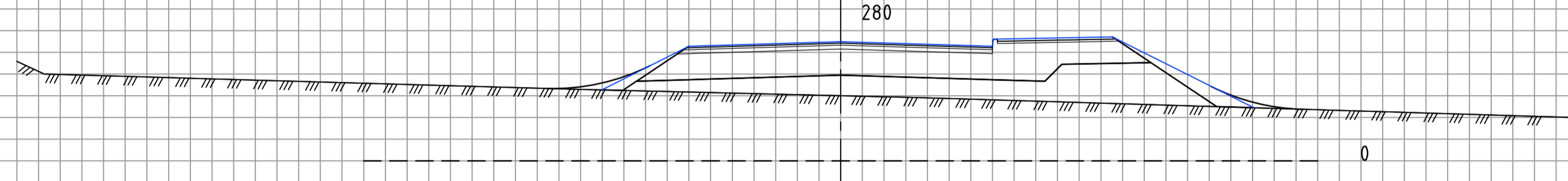
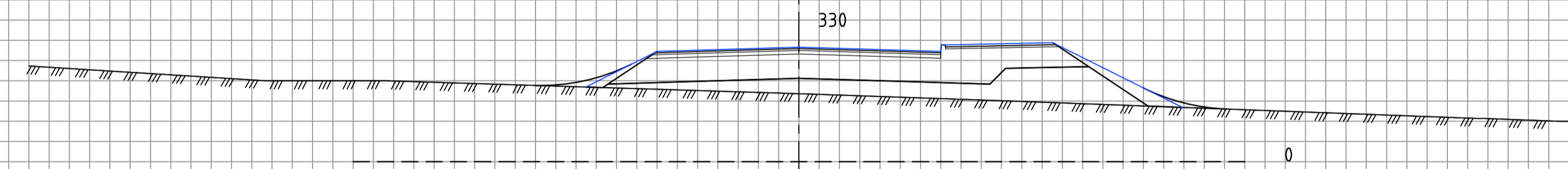
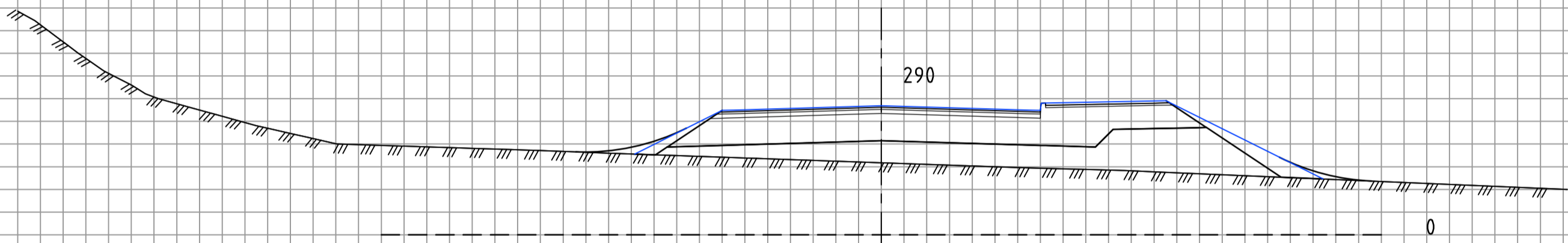
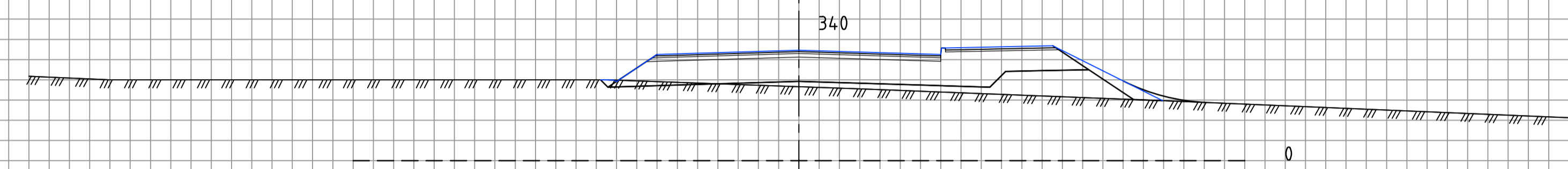
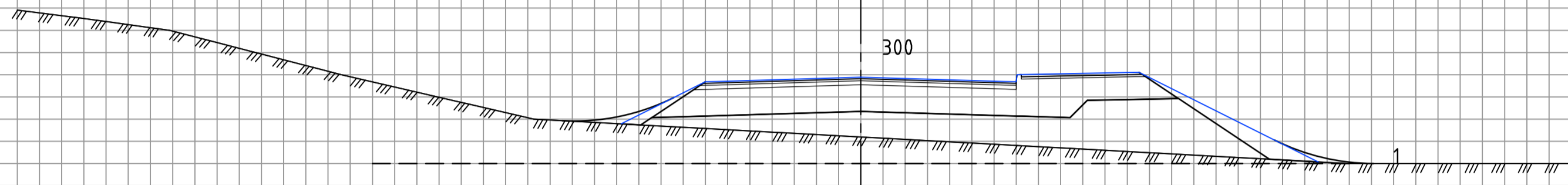
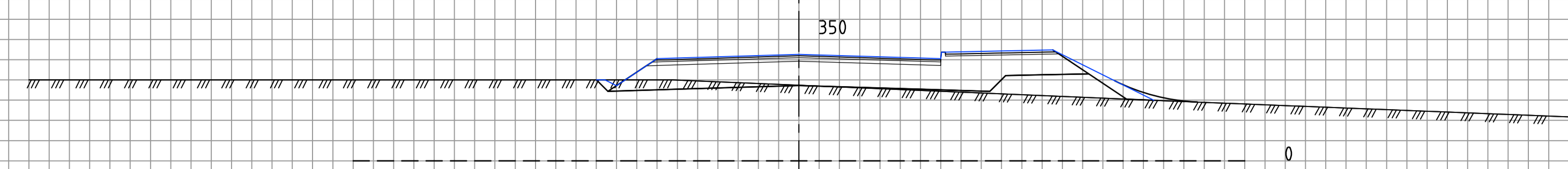
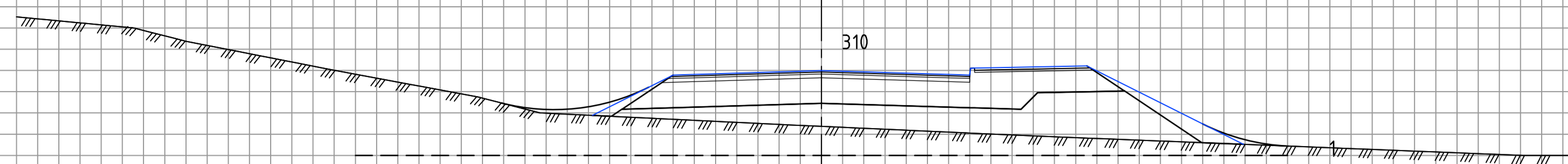

Rev.	Dato	Revideringen gjelder	Nr.	Saksb.	Sidem.k.	Oppdr.a.
Halden kommune			Tegnet av		Saksbehandler	
VA Tyska Hollenderen			ADBR		GLJ	
Tverrprofiler 270 - 350			Sidemannskont.		Oppdragsansvarlig	
			OLER		GLJ	
			Fag		Målestokk	
			VEG		A1: 1:100	
			Dato		A3: 1:200	
			19.12.2017			
COWI			Oppdragsnr.		Status	
RIF			A097057		Konkurransgrunnlag	
			Tegning nr.		Rev.	
					U004	



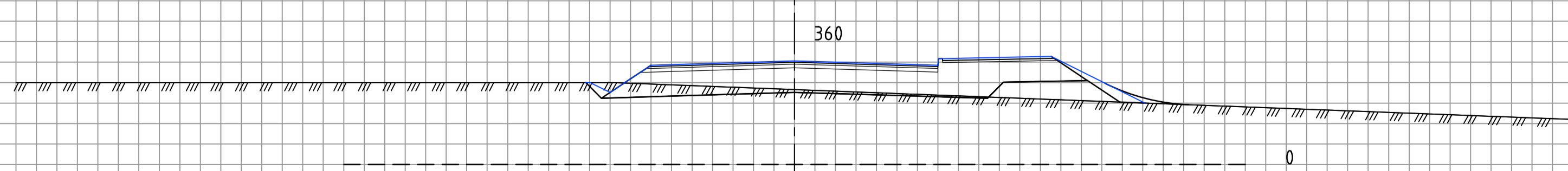
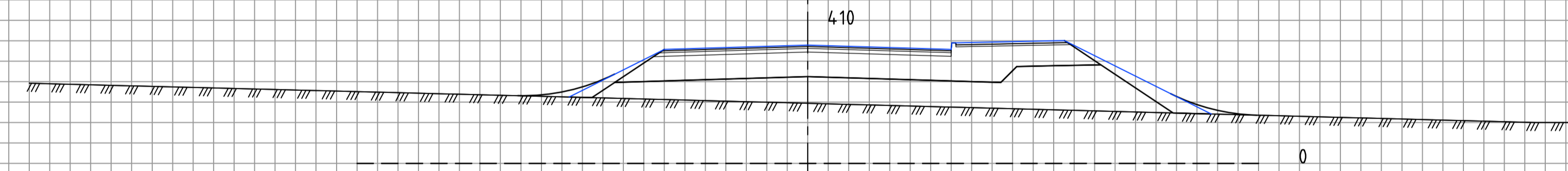
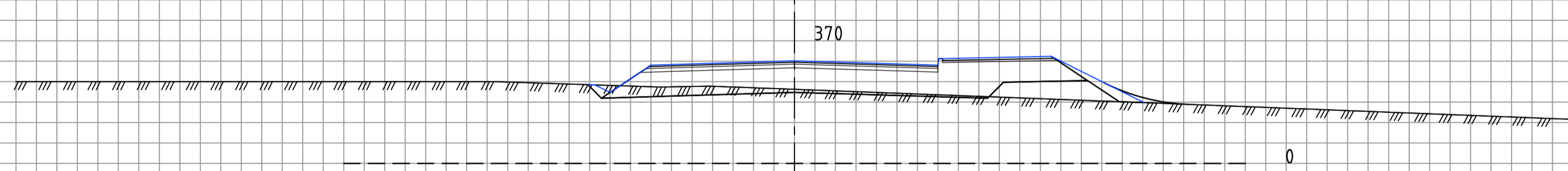
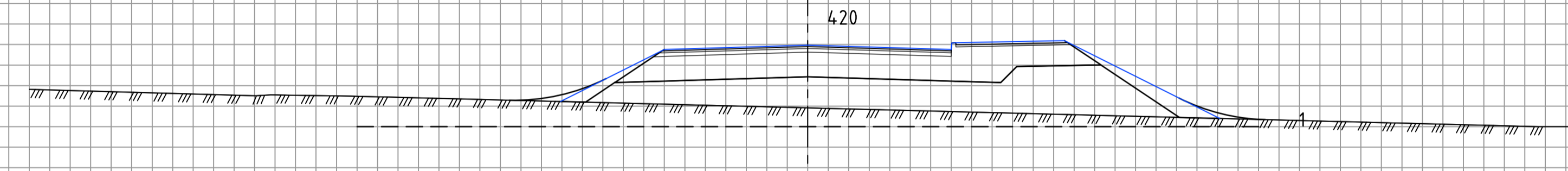
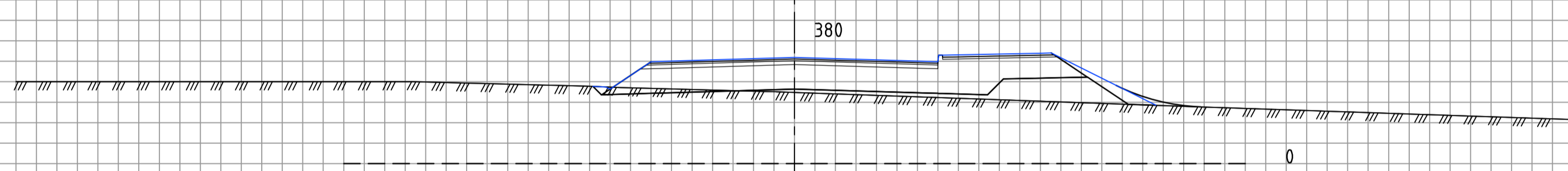
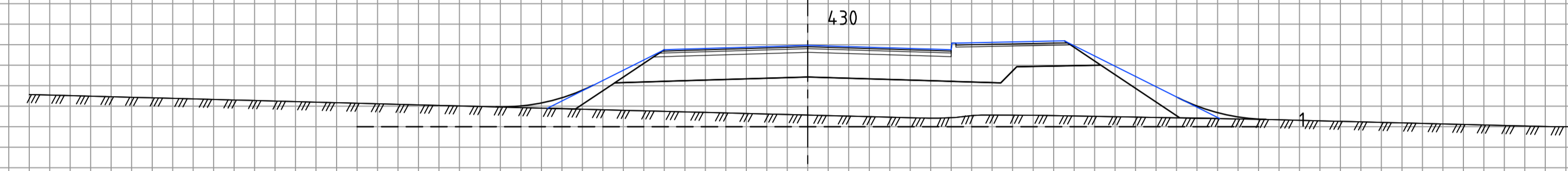
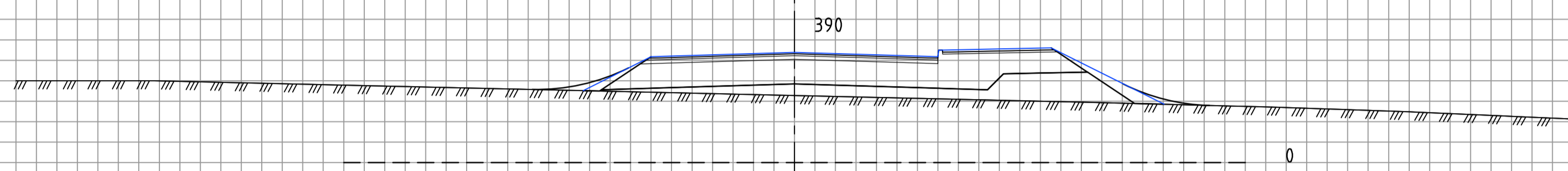
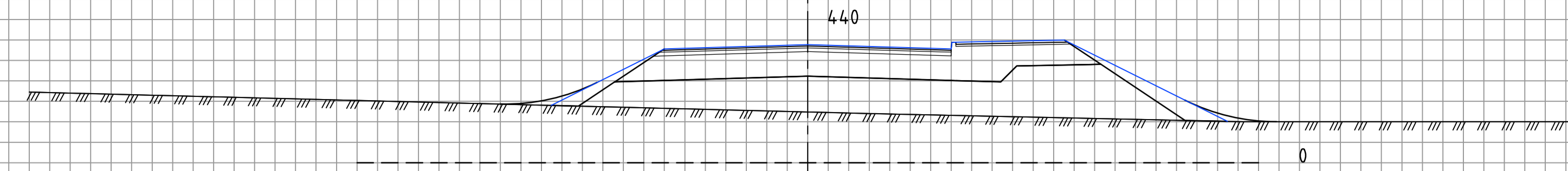
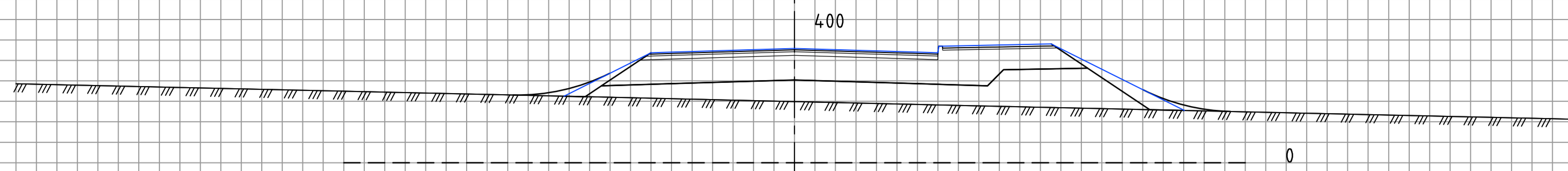

Rev.	Dato	Revideringen gjelder	Nr.	Saksb.	Sidem.k.	Oppdr.a.
Halden kommune			Tegnet av		Saksbehandler	
VA Tyska Hollenderen			ADBR		Saksbehandler	
Tverrprofiler 360 - 440			Sidemannskont.		Oppdragsansvarlig	
			OLER		GLJ	
			Fag		Målestokk	
			VEG		A1: 1:100	
			Dato		A3: 1:200	
			19.12.2017			
			Oppdragsnr.		Status	
			A097057		Konkurransgrunnlag	
			Tegning nr.		Rev.	
					U005	

**COWI**



U005

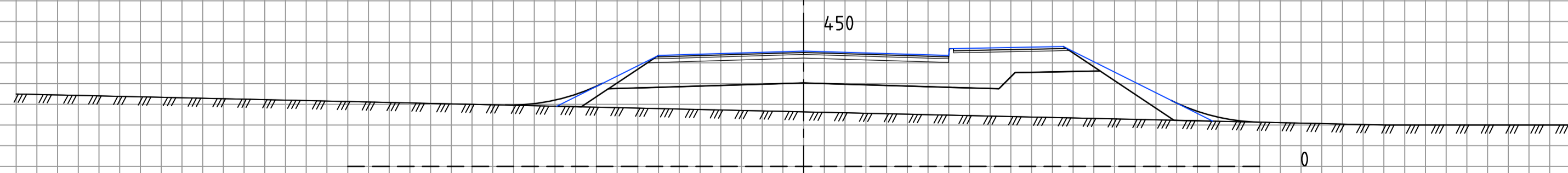
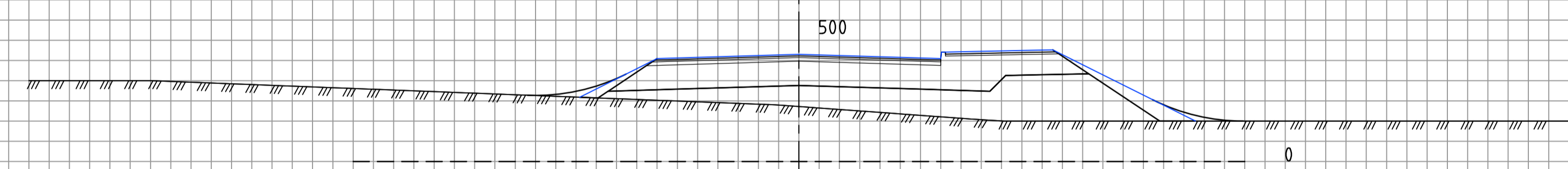
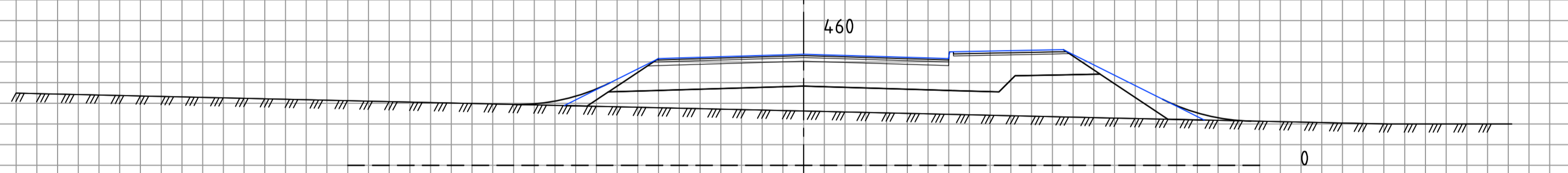
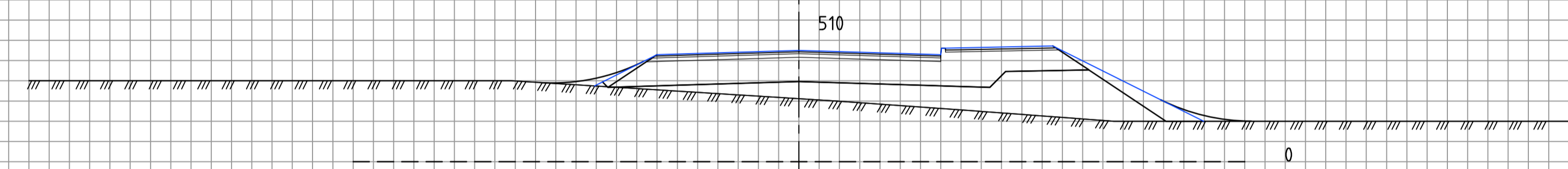
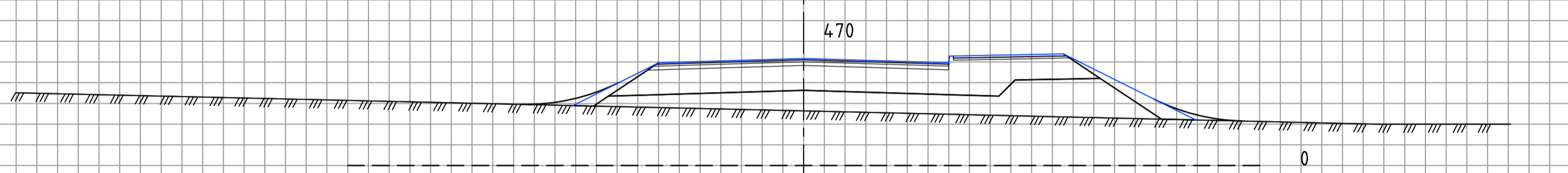
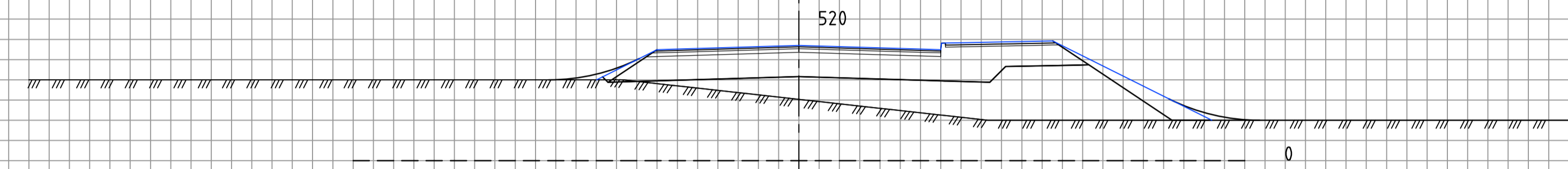
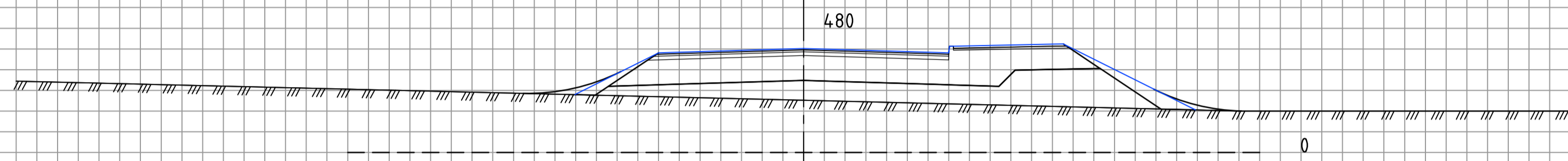
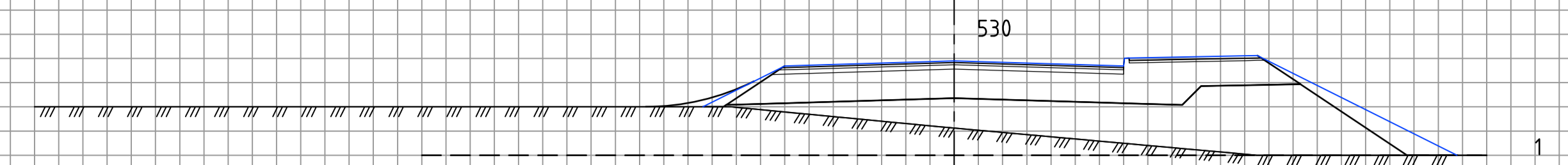
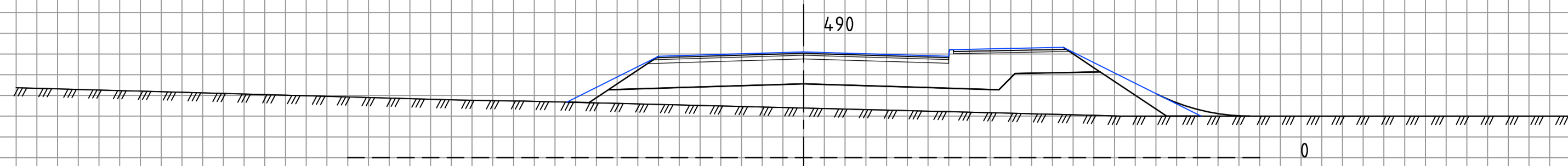

Rev.	Dato	Revideringen gjelder	Nr.	Saksb.	Sidem.k.	Oppdr.a.
Halden kommune			Tegnet av		Saksbehandler	
VA Tyska Hollenderen			ADBR		Saksbehandler	
Tverrprofiler 450 - 530			Sidemannskont.		Oppdragsansvarlig	
			OLER		GLJ	
			Fag		Målestokk	
			VEG		A1: 1:100	
			Dato		A3: 1:200	
			19.12.2017			
COWI			Oppdragsnr.		Status	
RIF			A097057		Konkurransgrunnlag	
			Tegning nr.		Rev.	
					U006	



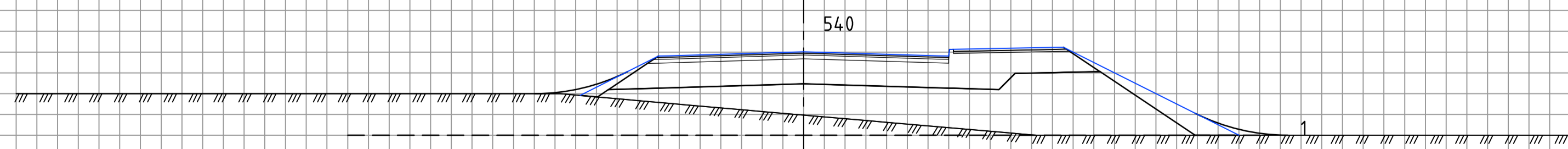
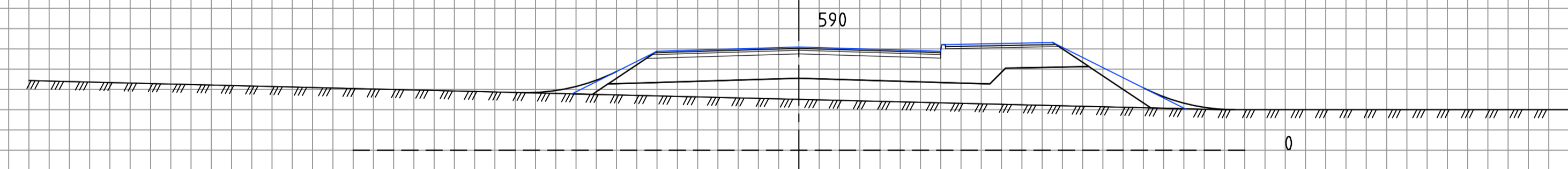
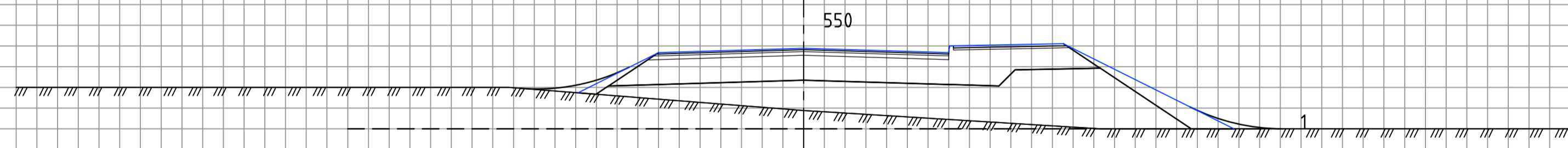
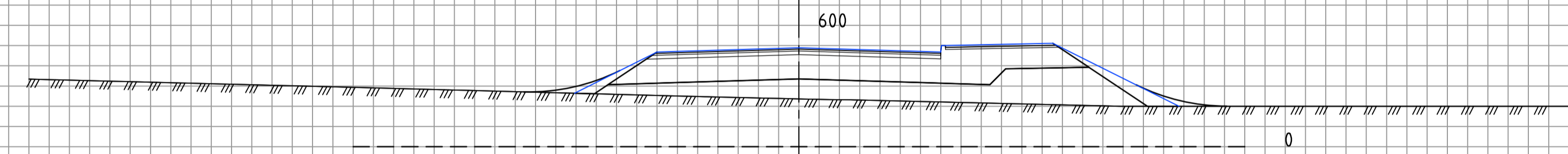
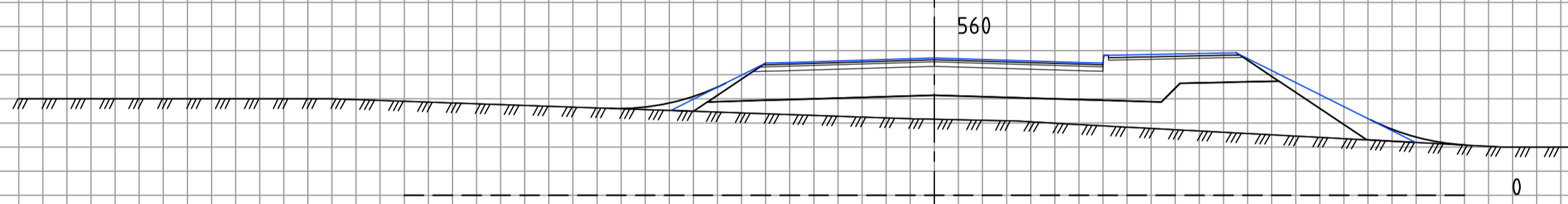
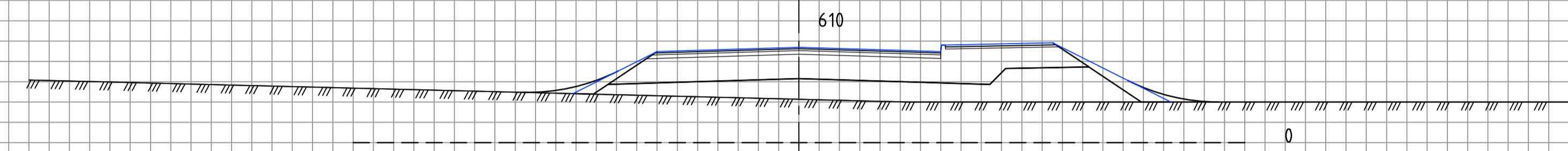
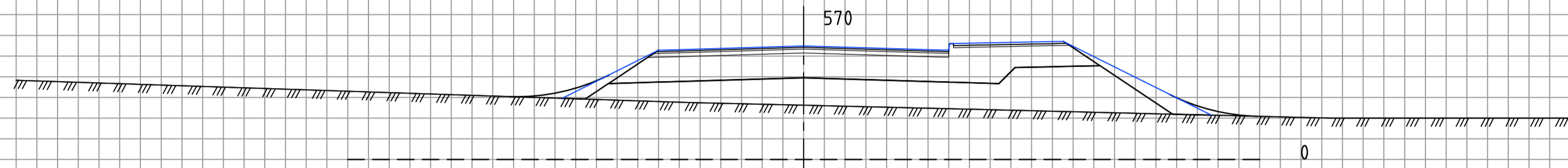
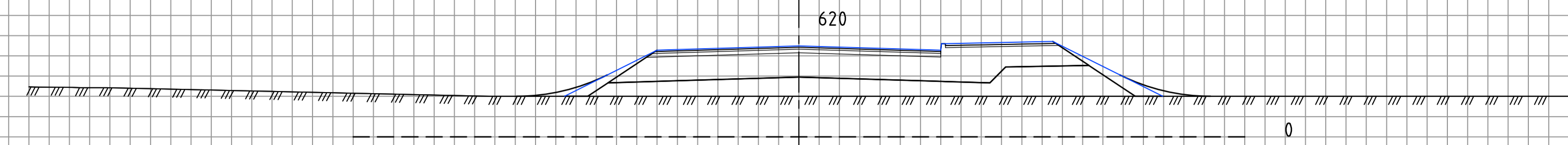
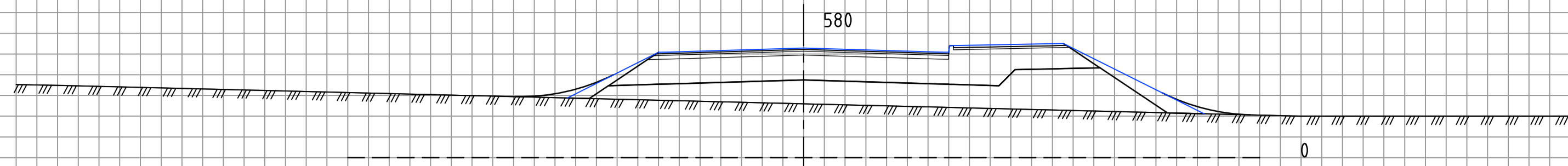

Rev.	Dato	Revideringen gjelder	Nr.	Saksb.	Sidem.k.	Oppdr.a.
Halden kommune			Tegnet av	Saksbehandler		
VA Tyska Hollenderen			ADBR	GLJ		
Tverrprofiler 540 - 620			Sidemannskontroll	Oppdragsansvarlig		
			OLER	GLJ		
			Fag	Målestokk		
			VEG	A1: 1:100		
			Dato	A3: 1:200		
			19.12.2017			
			Oppdragsnr.	Status		
			A097057	Konkurransgrunnlag		
			Tegning nr.	Rev.		
				U007		

**COWI**



U007

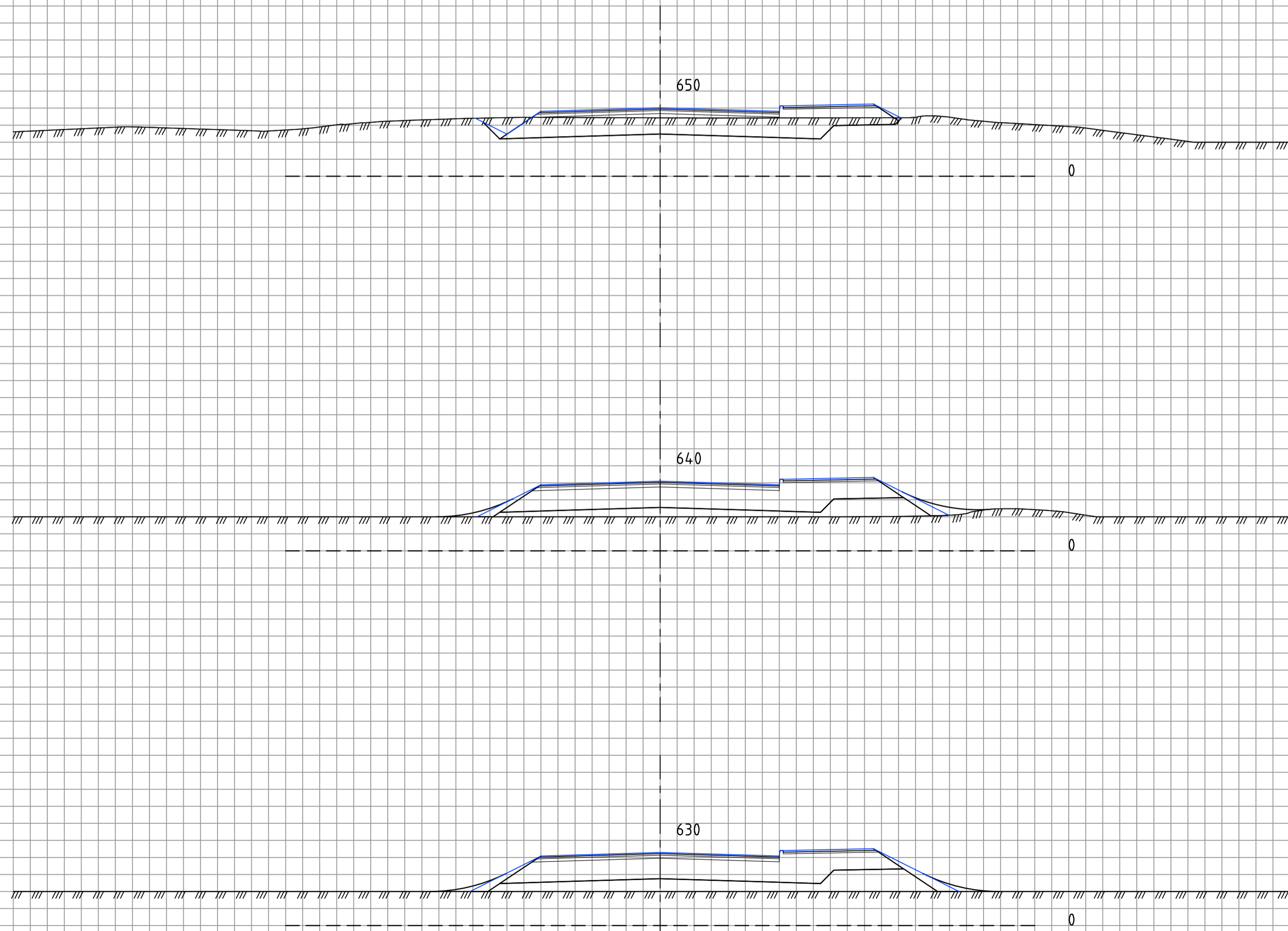

Rev.	Dato	Revideringen gjelder	Nr.	Saksb.	Sidem.k.	Oppdr.a.
Halden kommune			Tegnet av	Saksbehandler		
VA Tyska Hollenderen			ADBR	GLJ		
Tverrprofiler 630 - 650			Sidemannskont.	Oppdragsansvarlig		
			OLER	GLJ		
			Fag	Målestokk		
			VEG	A1: 1:100		
			Dato	A3: 1:200		
			19.12.2017			
COWI			Oppdragsnr.	Status		
RIF			A097057	Konkurransgrunnlag		
			Tegning nr.	Rev.		
				U008		